

1.

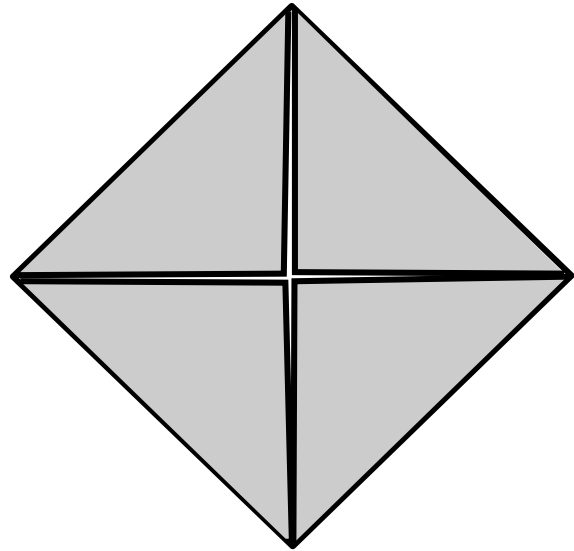

2.

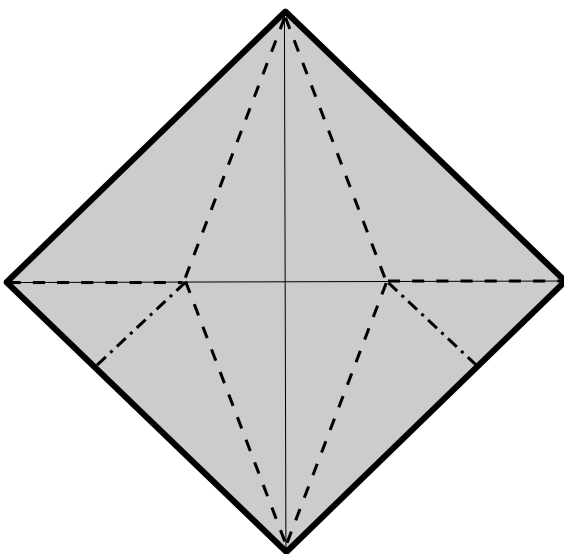

3. Base du poisson.

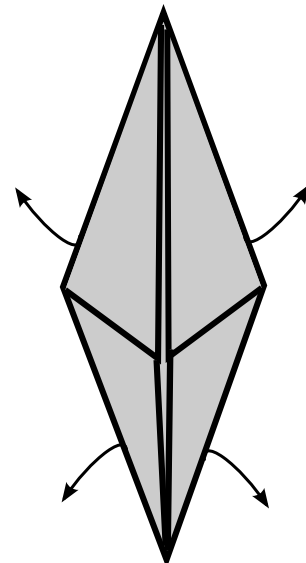

4. Déplier les volets.

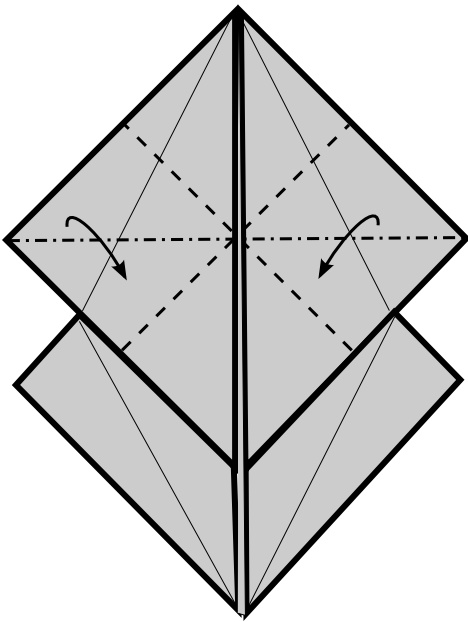

5.

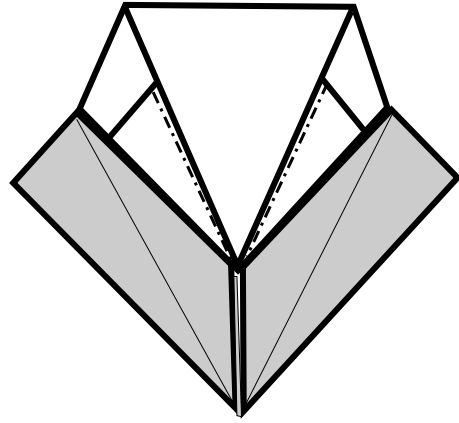

6. Plis inversés

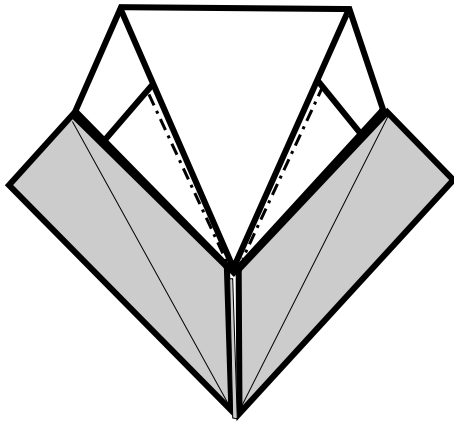

7. Plis inversés

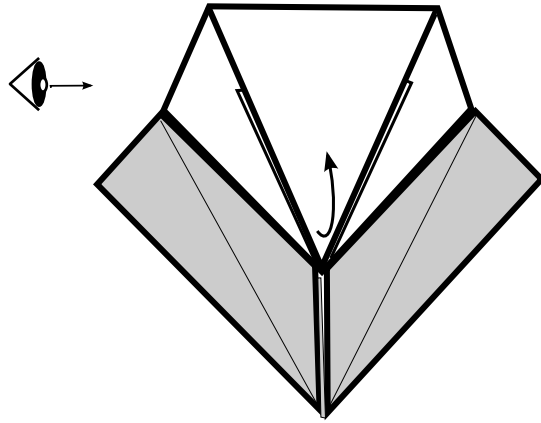

8. Tirer la pointe (pour former une base de l'oiseau étirée). Le modèle n'est plus plat.

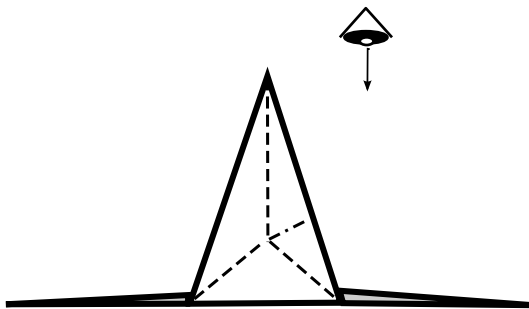

9. Plis oreille de lapin sur les 2 pointes.  
Le modèle redevient plat.

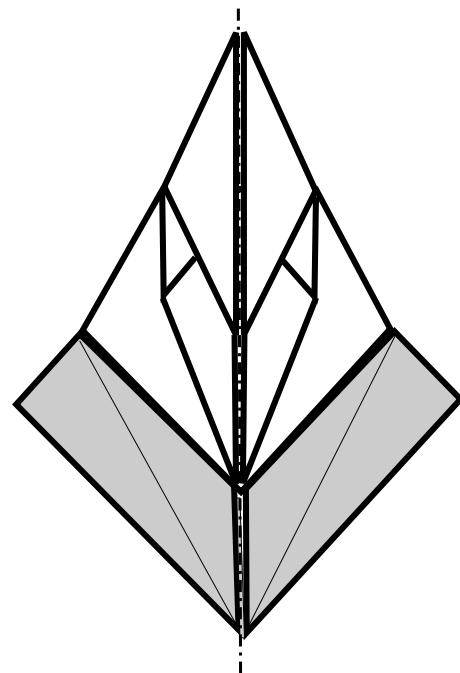

10. Plier le modèle en 2.

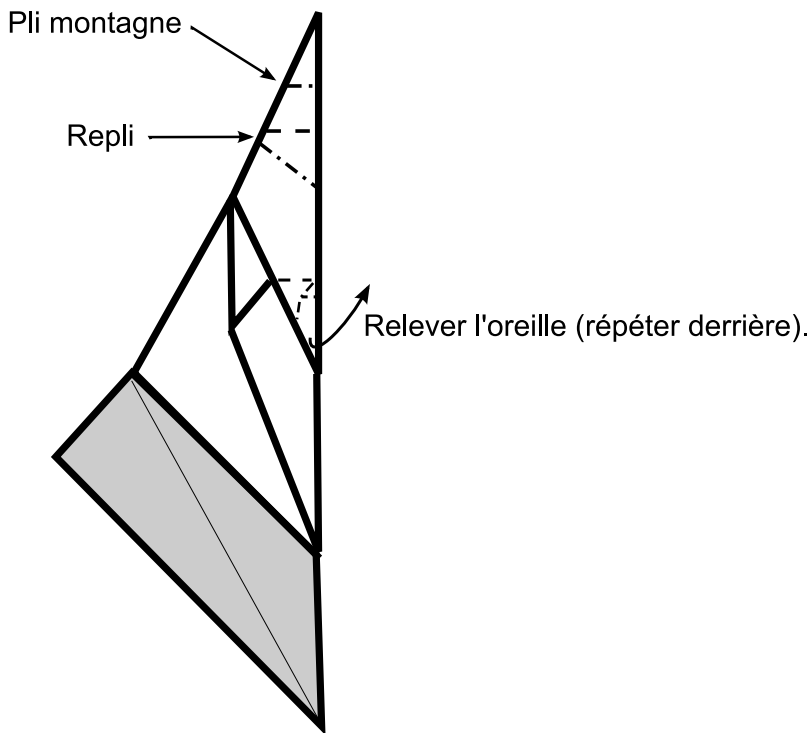

11. Former la tête.

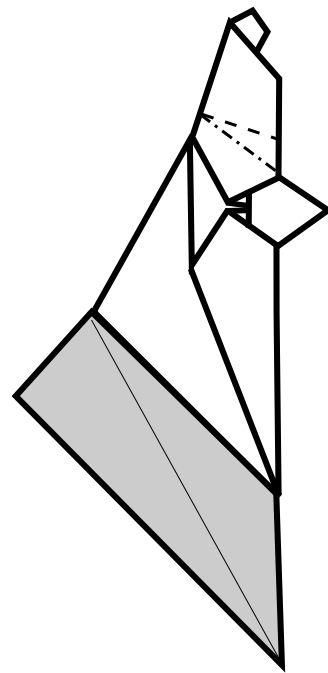

12. Encore un repli pour la tête.

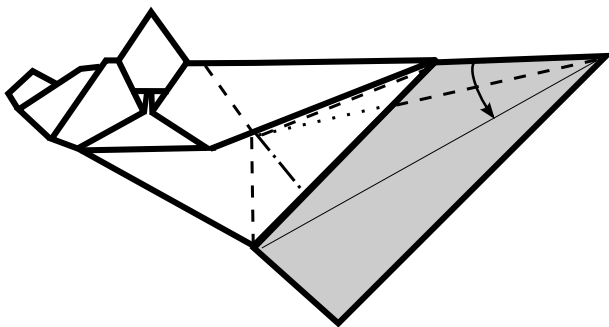

13. Rabattre la patte avant.  
Répéter derrière.

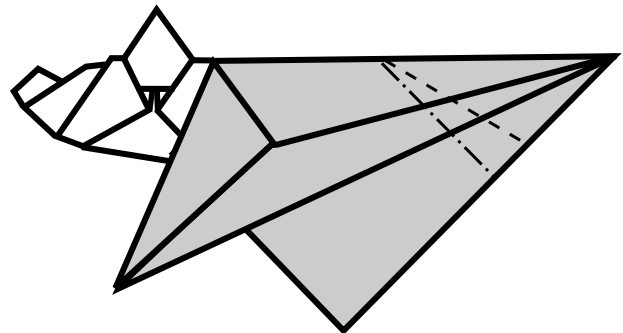

14. Repli.

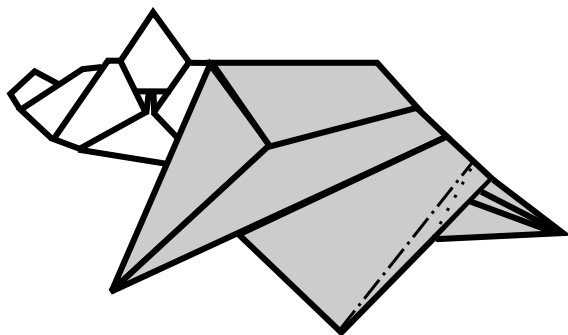

15. Pli inversé.  
Répéter derrière.

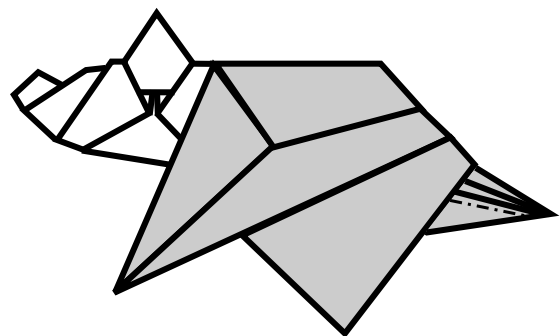

16. Affiner la queue par un pli montagne.  
Répéter derrière.

