

Chat

Yann Mouget
2015

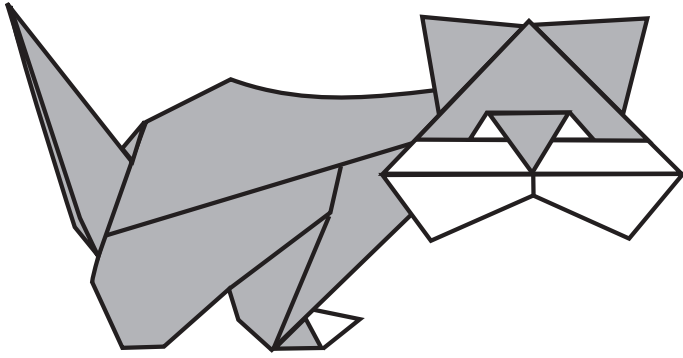

Modèle inspiré par la base
du renard de Hoàng Tien Quyet

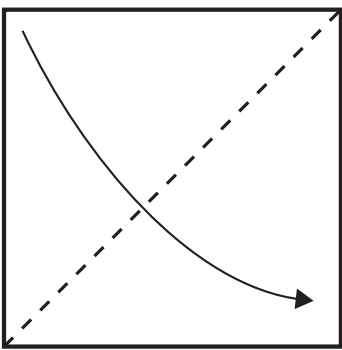

1.

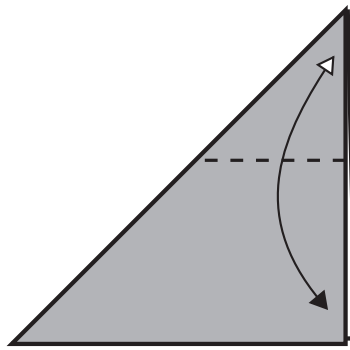

2. Plier, déplier.

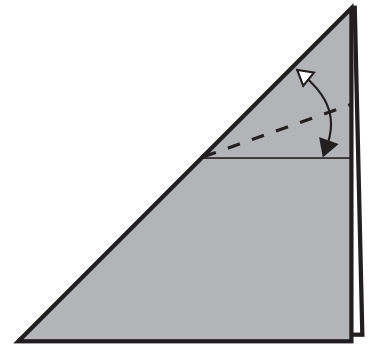

3. Plier, déplier.

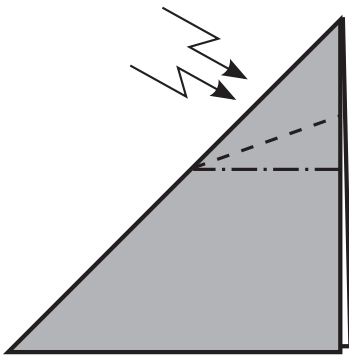

4. Crimp.

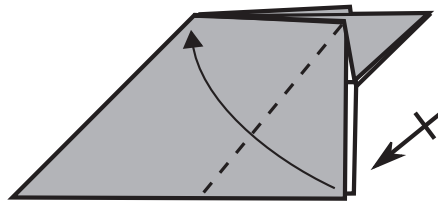

5.

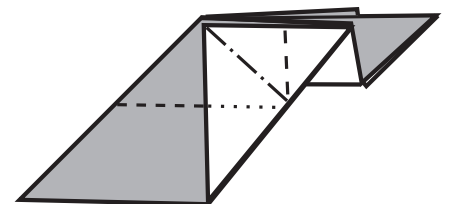

6. Pli inversé extérieur.

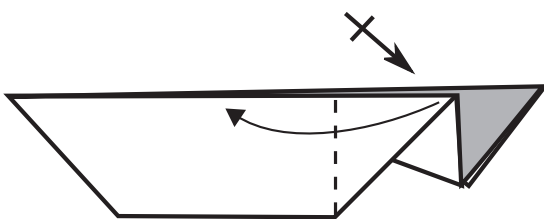

7.

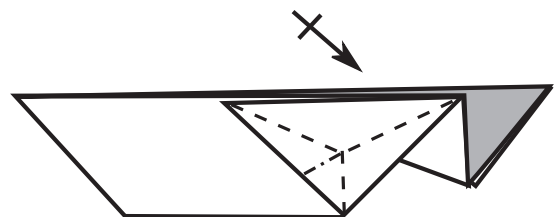

8.

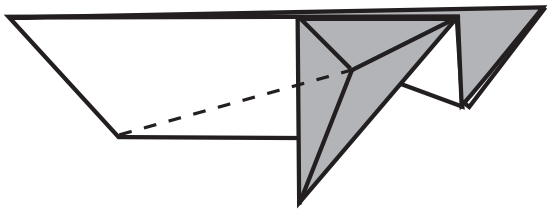

9. Pli inversé extérieur.

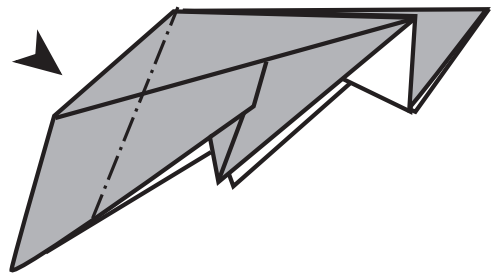

10. Pli inversé intérieur.

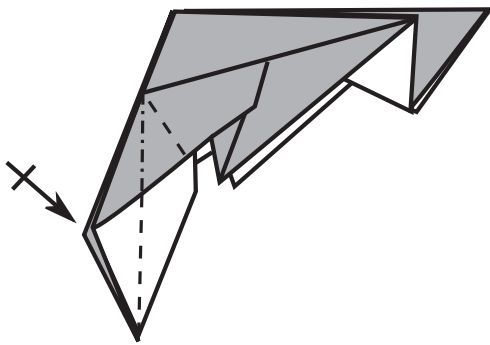

11.

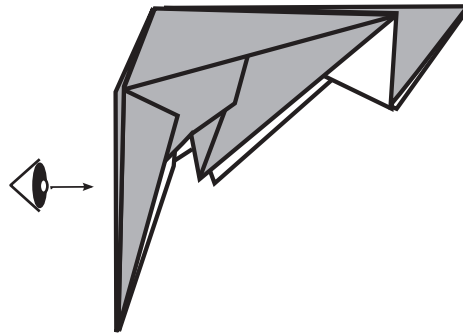

12. Ouvrir la pointe.

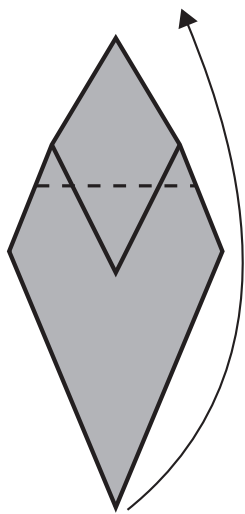

13.

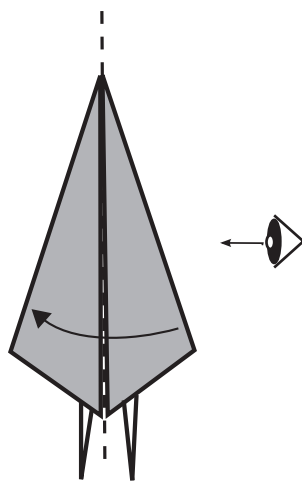

14. Refermer la pointe.

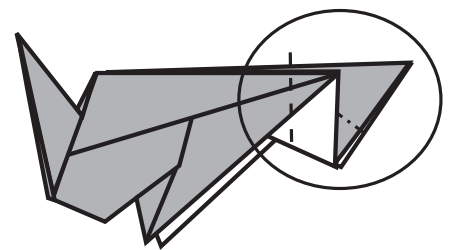

15. Pli aplati.

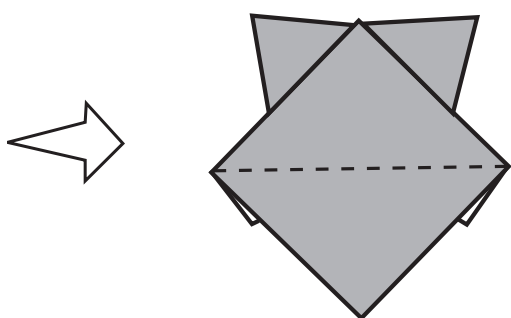

16.

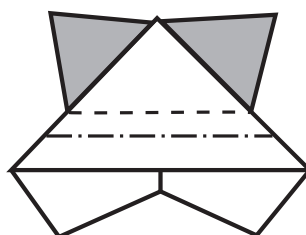

17.

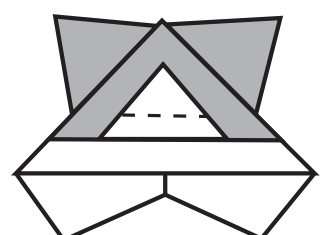

18.

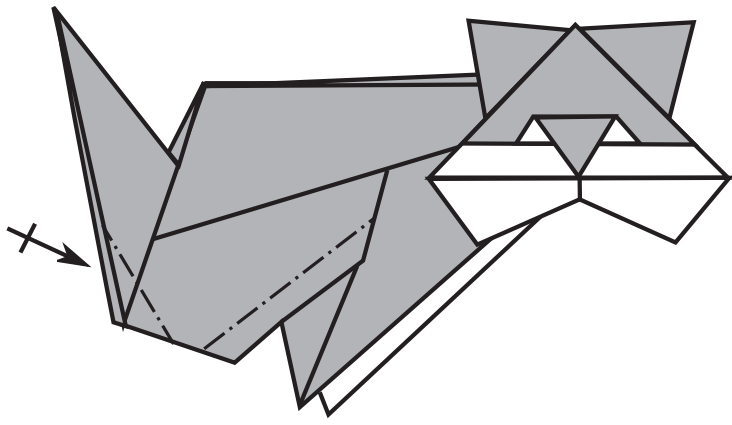

19.

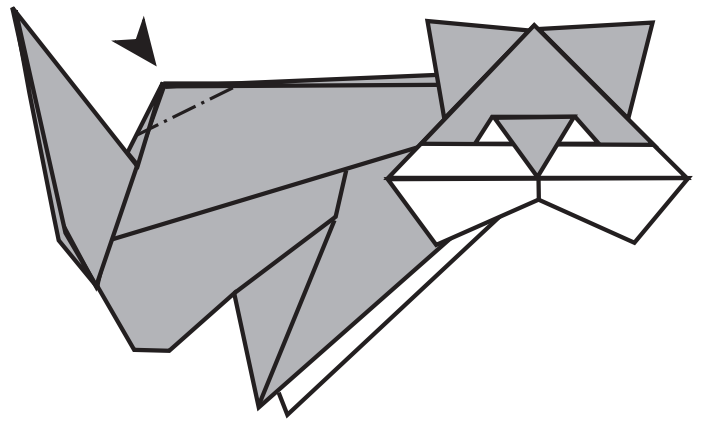

20. Sink.

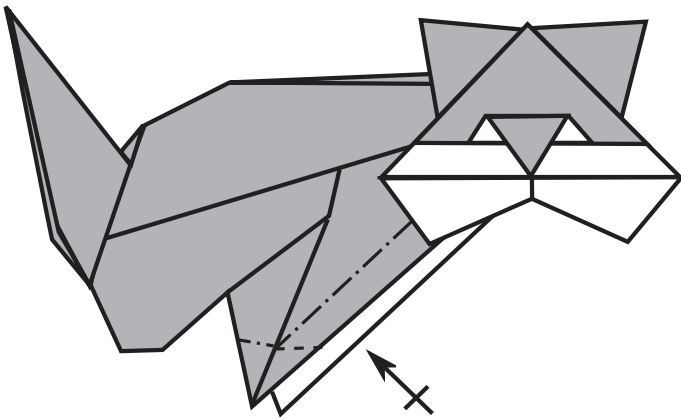

21. Pincer les pattes avant.

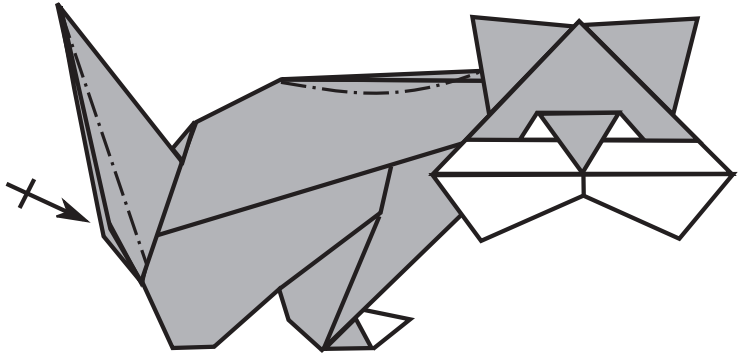

22. Affiner la queue, modeler le dos.

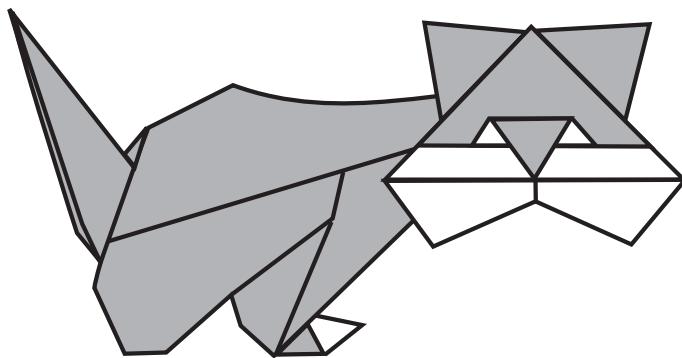

23.