

Un cocker dans son panier  
modèle et diagramme Matthieu Chicouène, Mai 2018

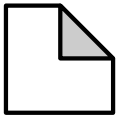

papier bicolore

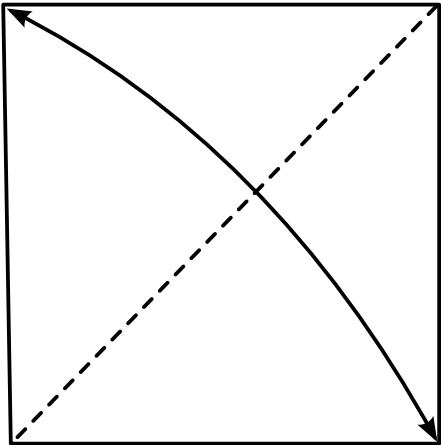

1

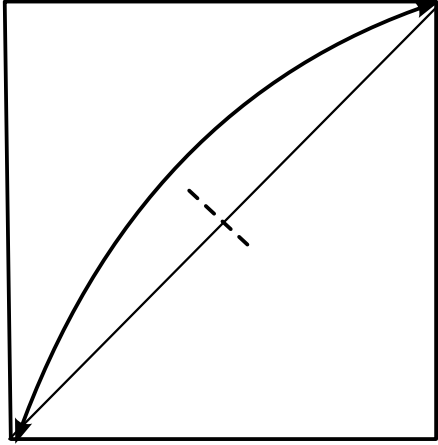

2

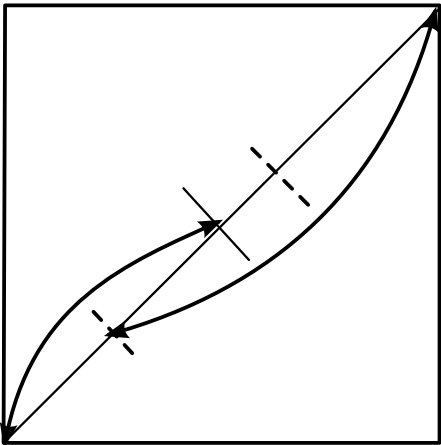

3

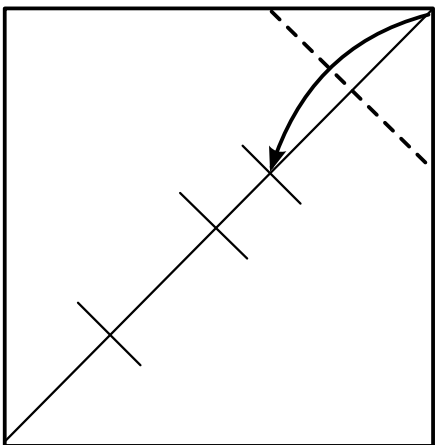

4

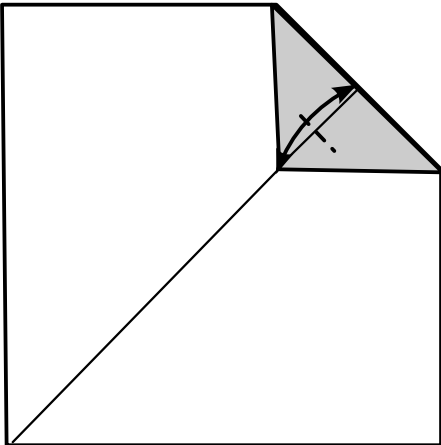

5

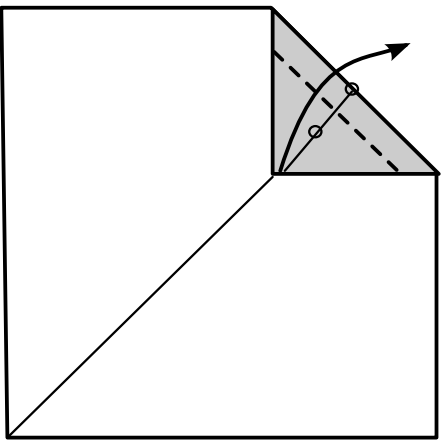

6

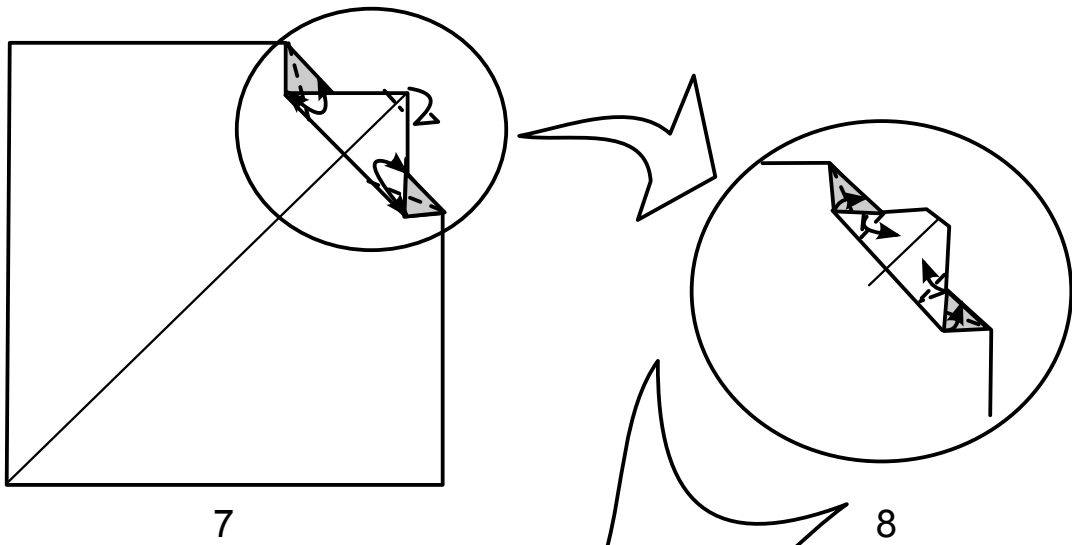

7

8

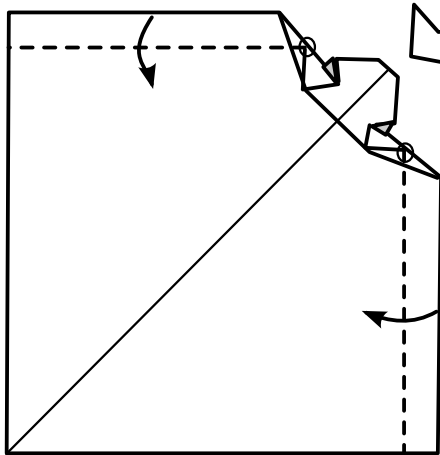

9

10

plier les 2 couches

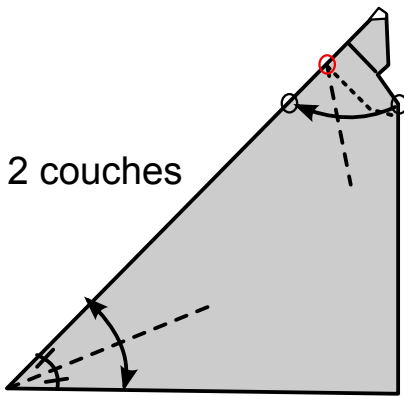

11

plier les 2 couches

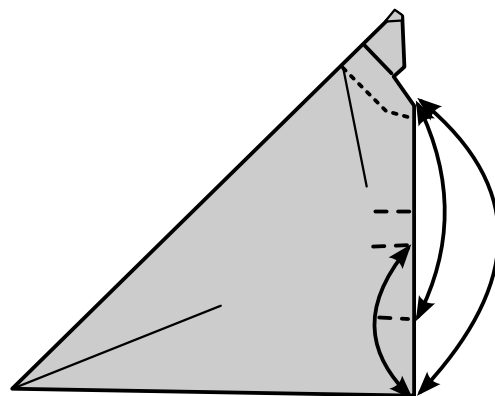

12

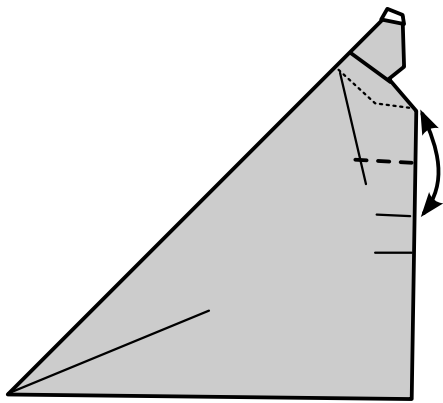

13

plier les 2  
couches

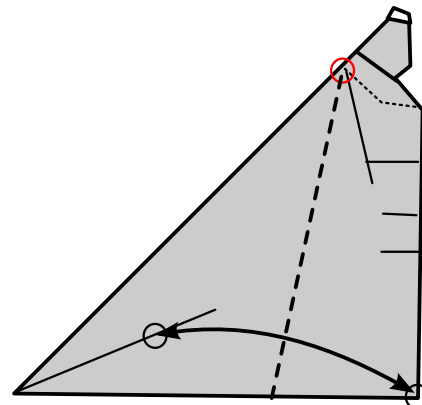

14

plier les 2  
couches

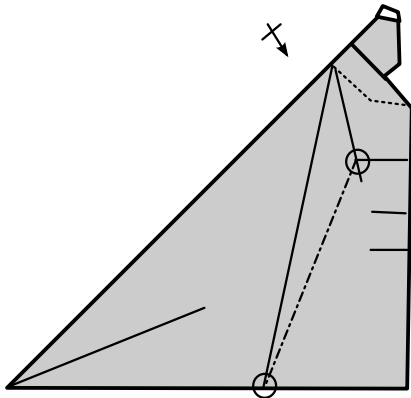

15

plier  
déplier

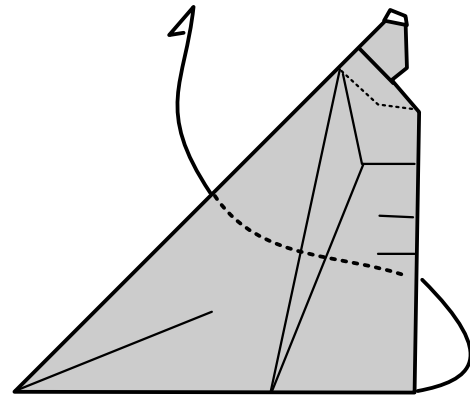

16

ouvrir

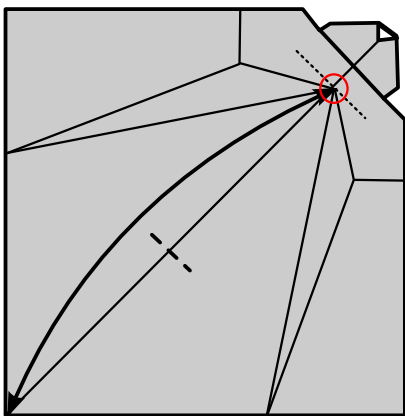

17

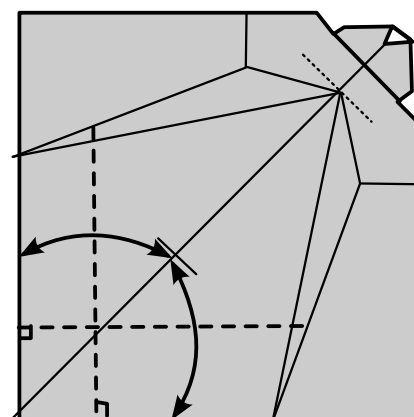

18

1 -> 2 -> 3 ou tout en même temps si le cœur vous en dit

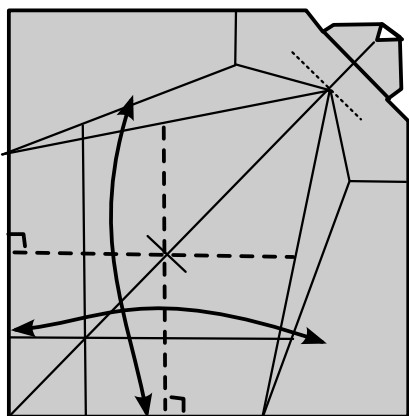

19

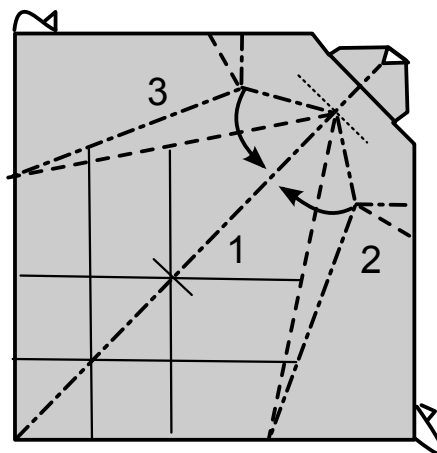

20

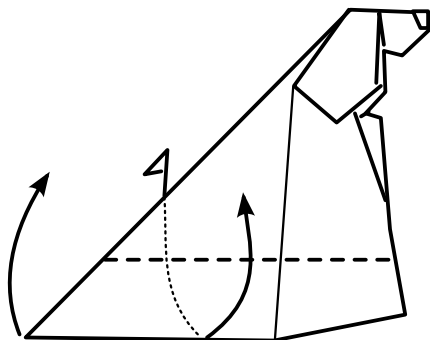

21

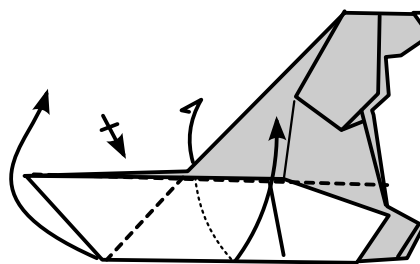

22

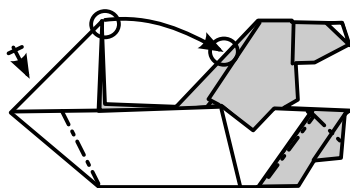

23

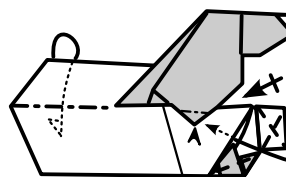

24

former une pointe puis l'insérer dans la poche

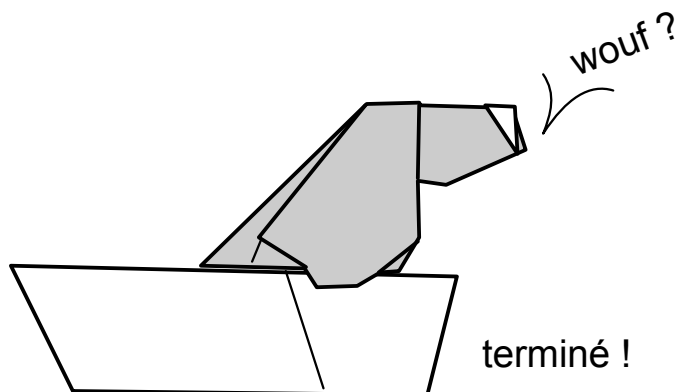

terminé !

*J. Colonne*  
M.  
3-105/18