

Loup d'hiver

Difficulté : ***

Modèle et diagramme : Lucien Derainne

Utiliser un papier translucide (papier cuisson, cristal, calque, etc.)

15 X 15 cm

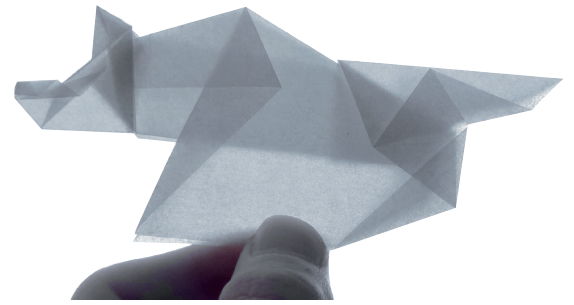

1.

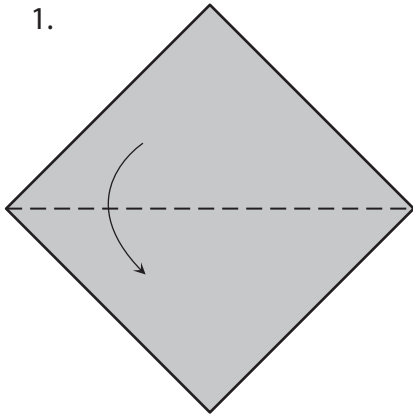

2.

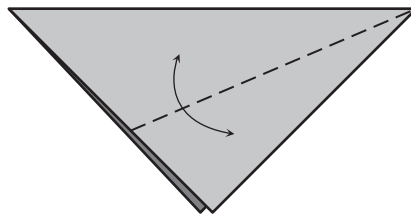

3.

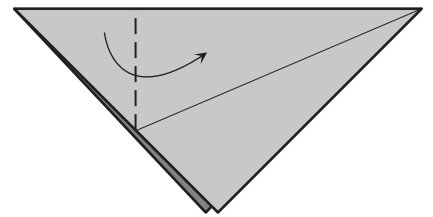

4.

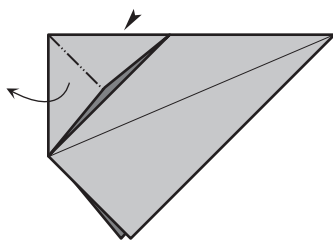

5.

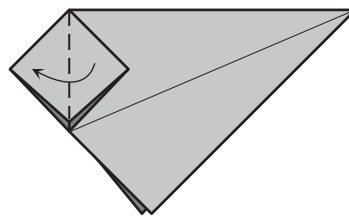

6.

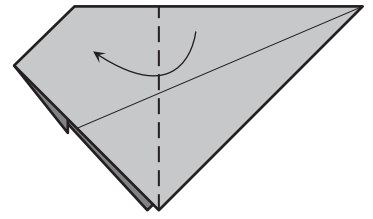

7.

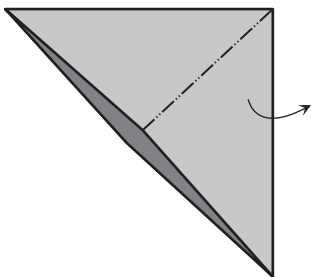

8.

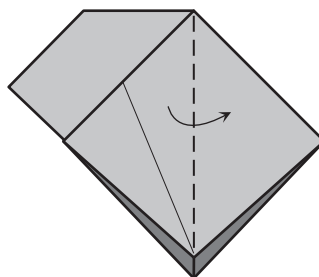

9.

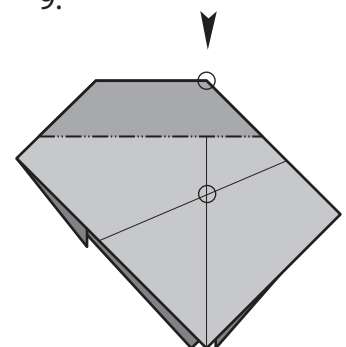

Enfoncement ouvert.

10.

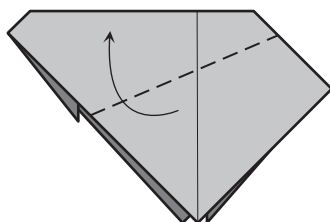

11.

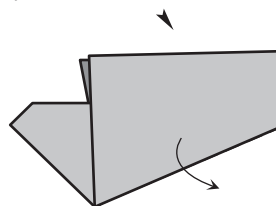

Rabaisser deux couches en incorporant un pli aplati.

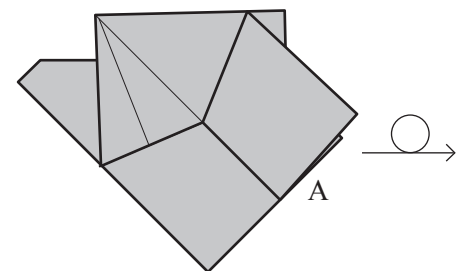

Résultat. Les bords sont alignés en A. Retourner.

12.

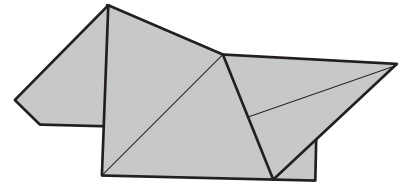
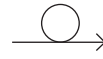
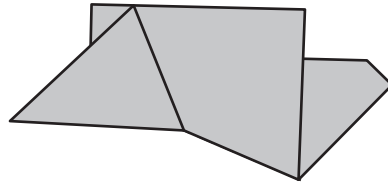
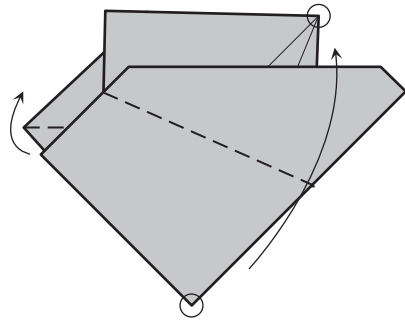

Résultat. Retourner.

13.

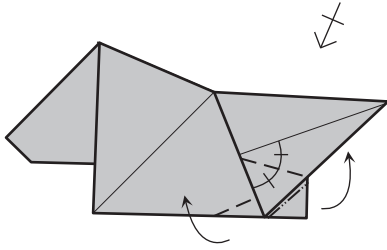

Pli pivot.

14.

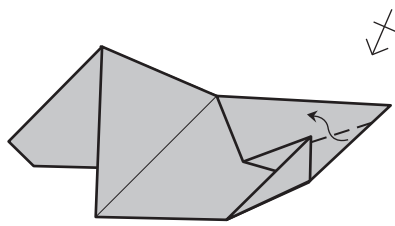

Pli inversé intérieur avec un léger décalage en haut.

15.

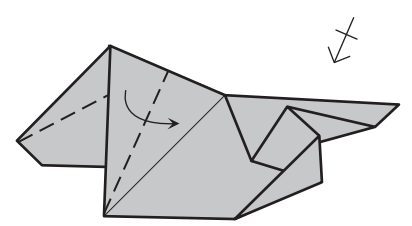

Pli pivot.

16.

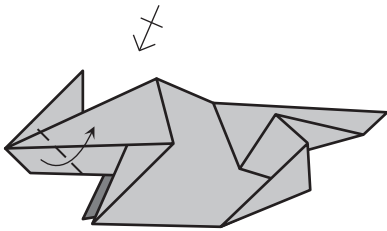

17.

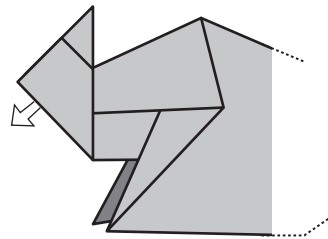

18.

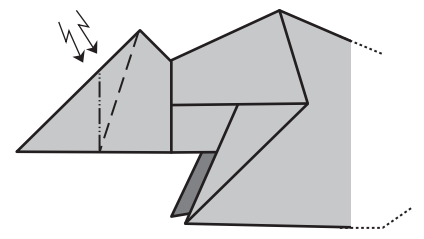

19.

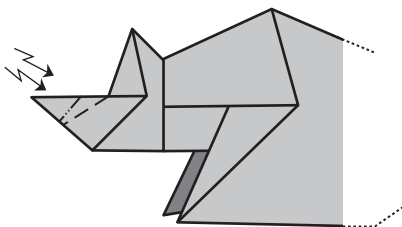

20.

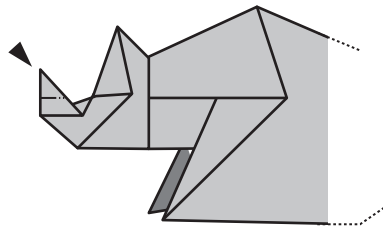

Regardez votre loup par transparence !

