

Le bélier

D'Eric Vigier.

(2005)

1

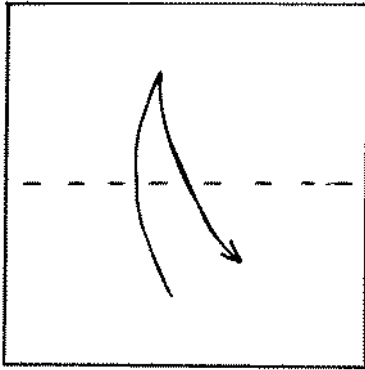

2

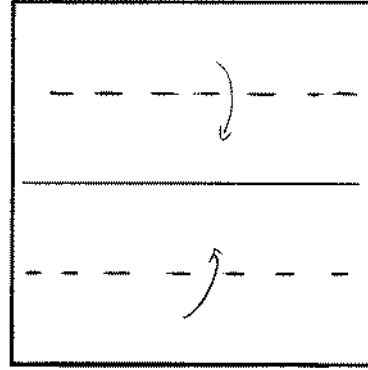

3

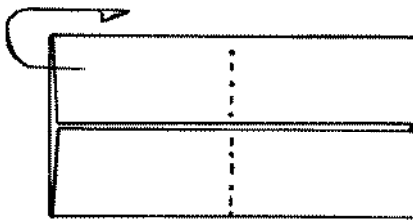

4

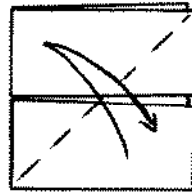

5

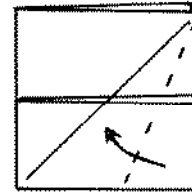

6

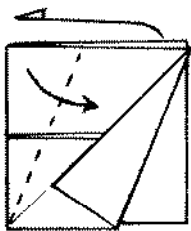

7

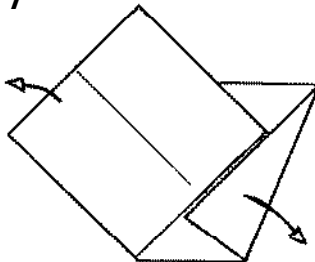

8

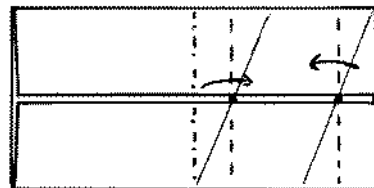

9

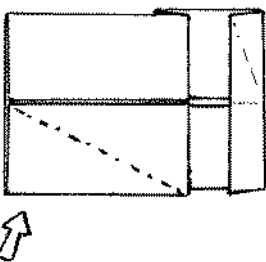

10

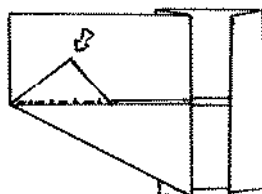

11

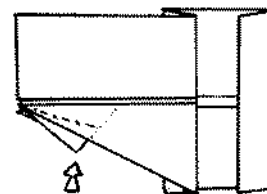

12

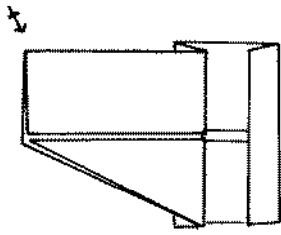

13

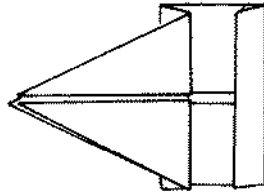

14

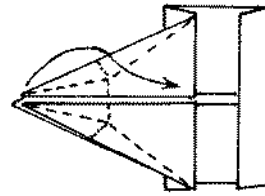

15

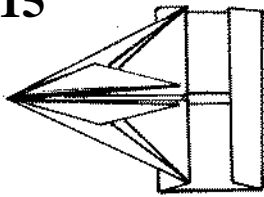

16

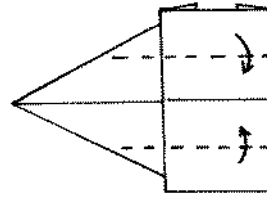

Déplier l'étape 14 et retourner le modèle.

17

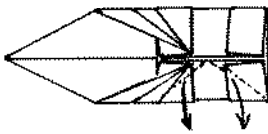

18

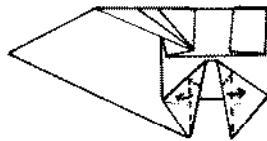

19

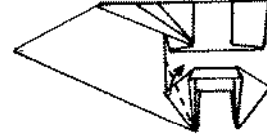

20

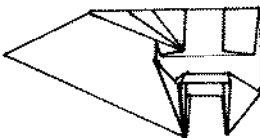

21

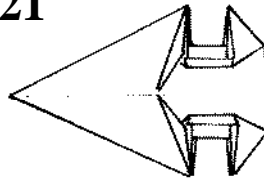

22

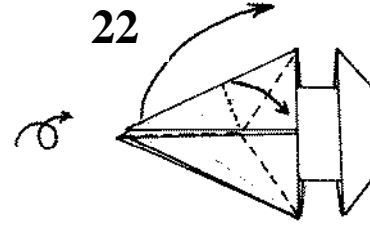

Répéter les opérations 17 à 19.

23

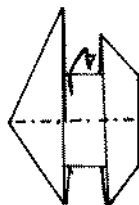

24

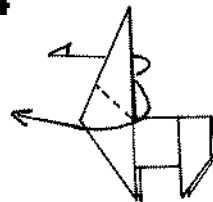

25

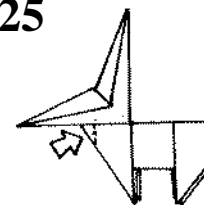

26

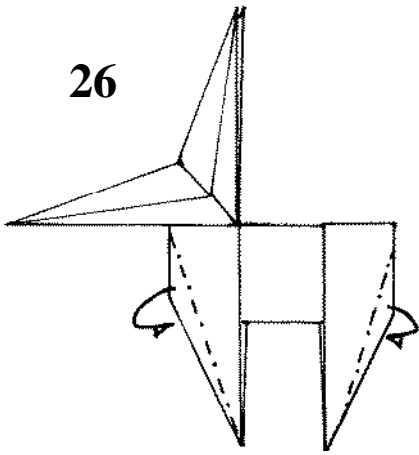

Répéter derrière.

27

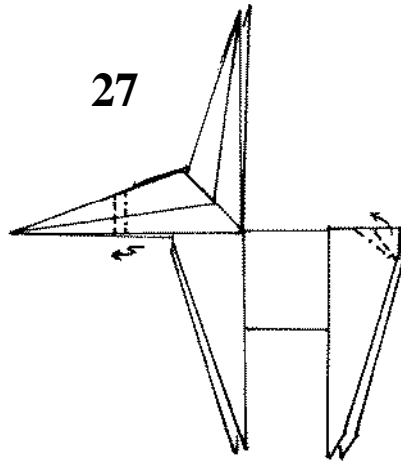

28

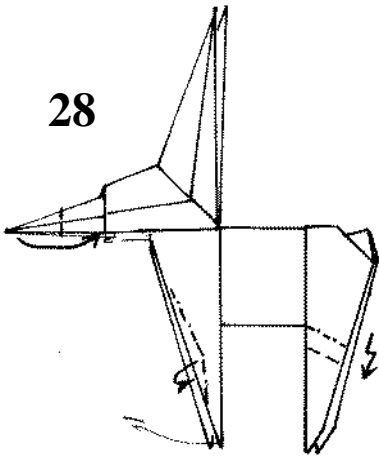

Répéter derrière.

29

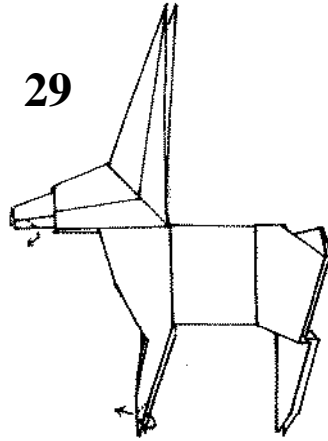

Répéter derrière.

30

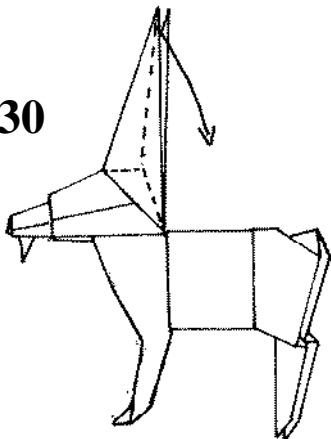

Pli oreille de lapin.
Répéter derrière.

31

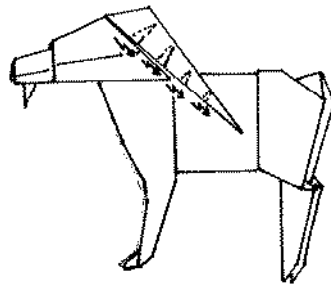

Répéter derrière.

32

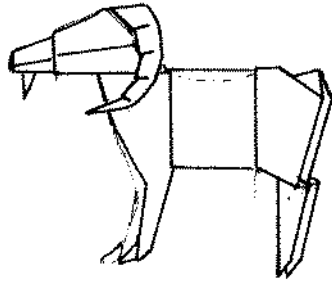

Pour le modelage final arrondir toute la tête.
Vous pouvez remonter les cornes plus haut
sur la tête.

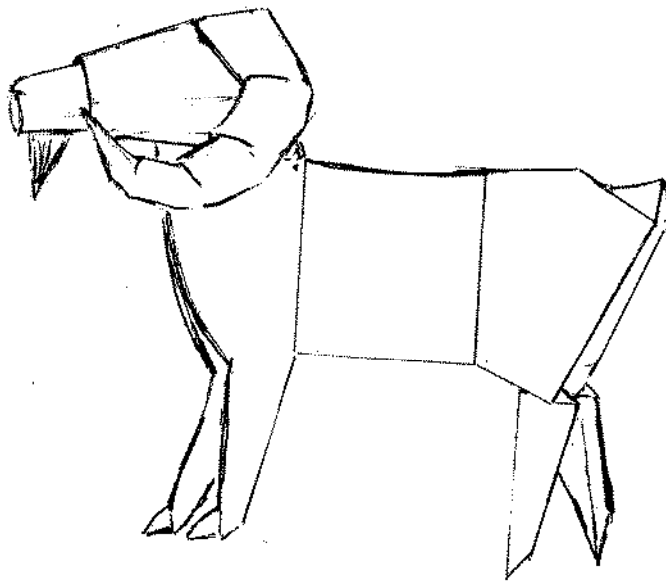

Le bélier terminé.

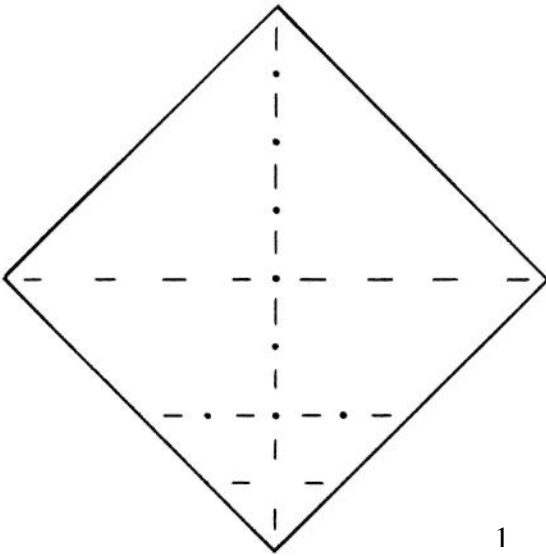

1

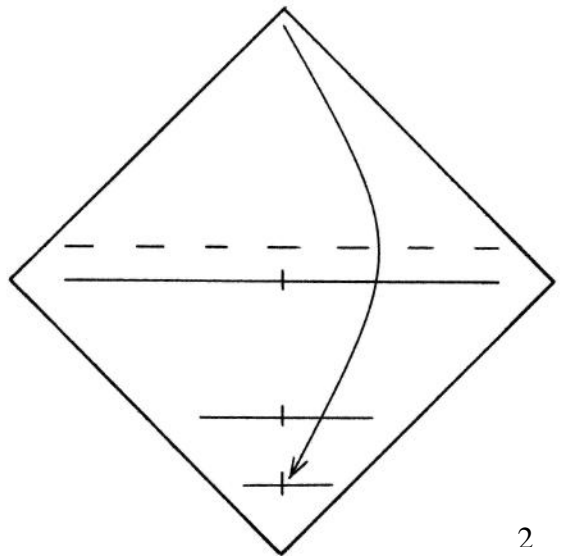

2

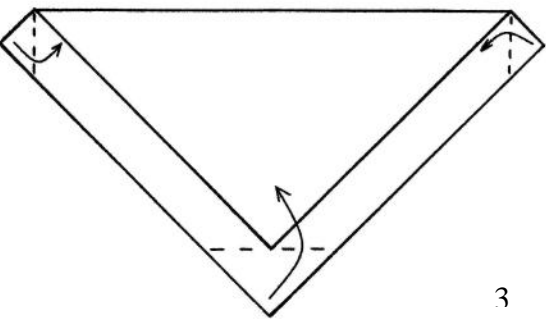

3

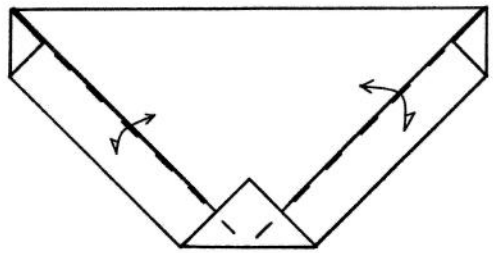

4

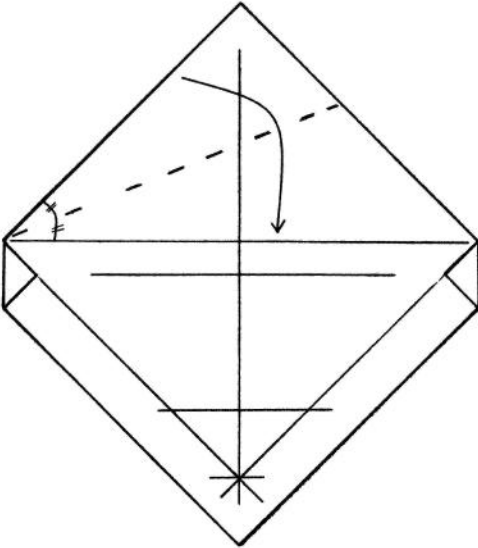

5

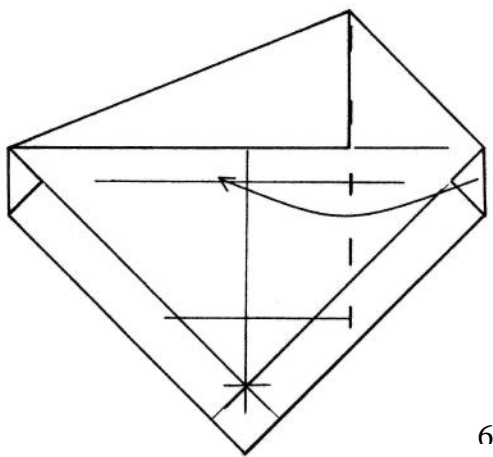

6

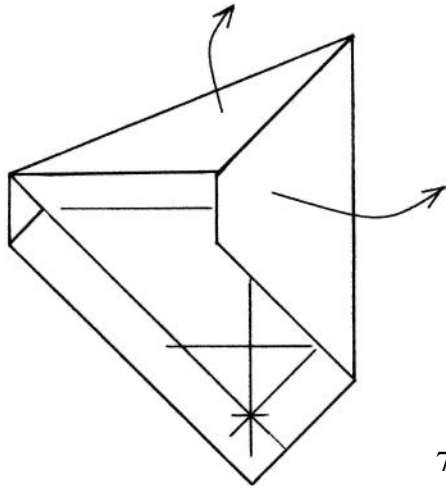

7

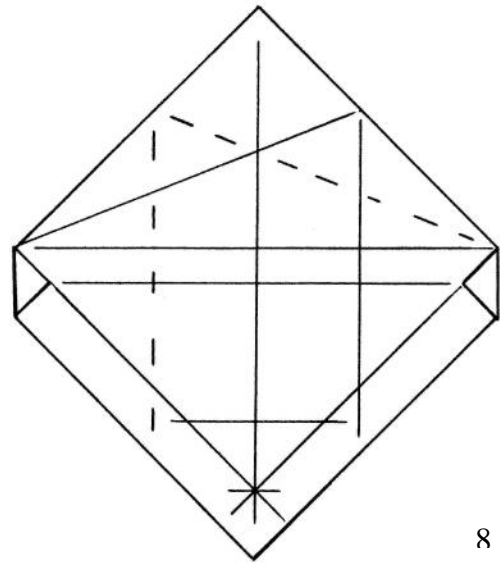

8

Répéter les étapes 5 à 7

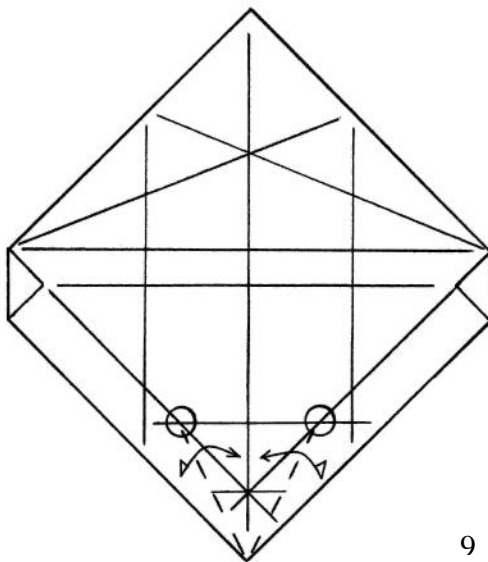

9

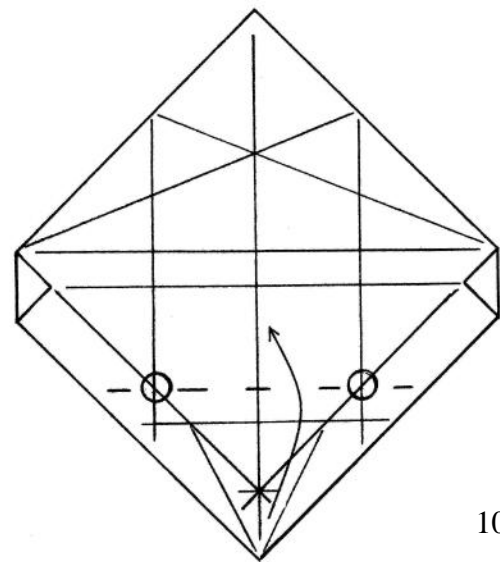

10

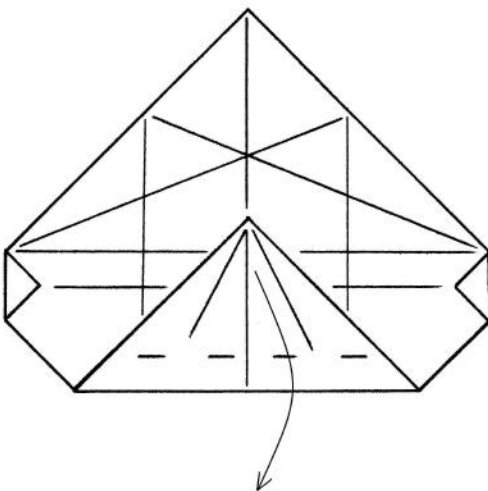

11

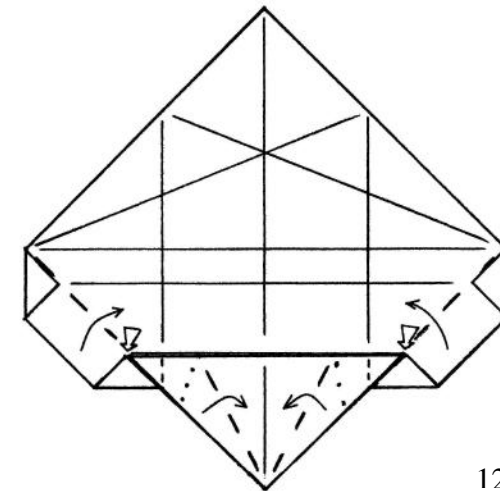

12

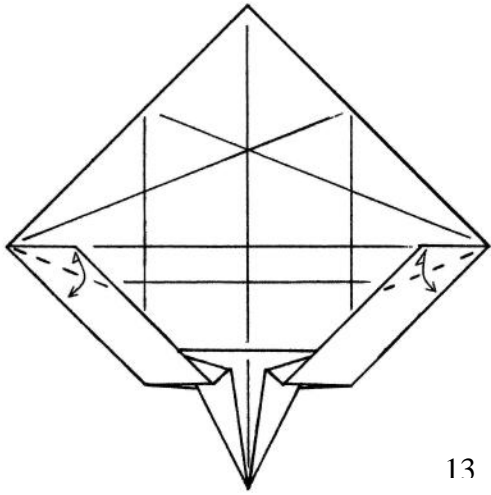

13

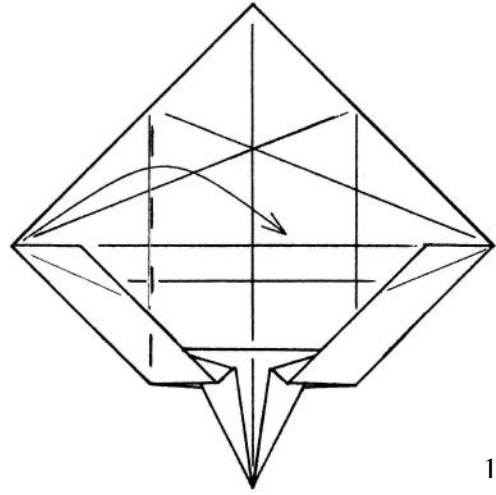

14

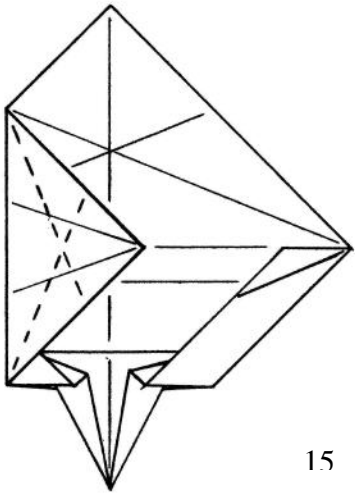

15

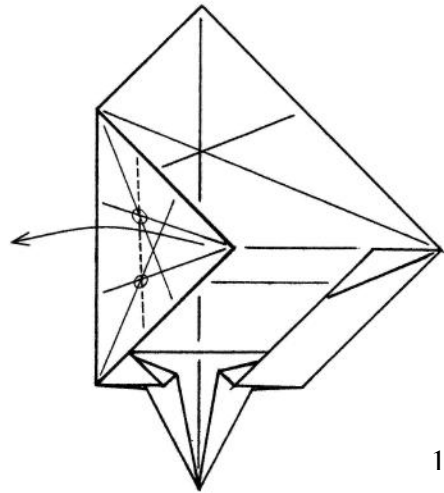

16

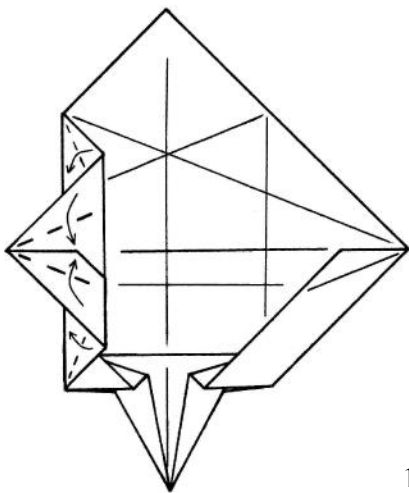

17

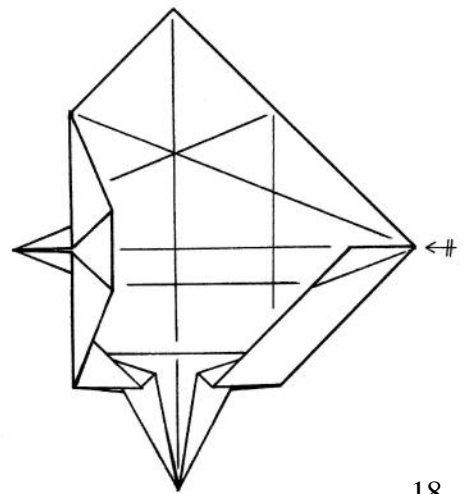

18

Répéter les étapes 14 à 17

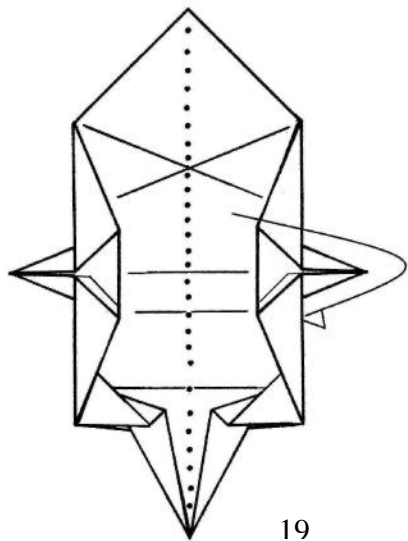

19

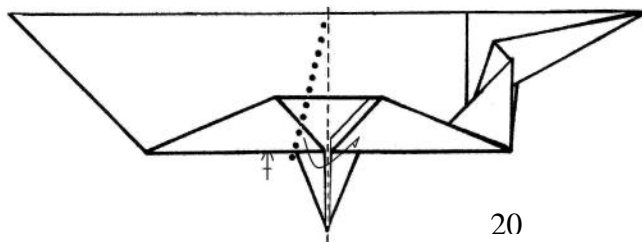

20

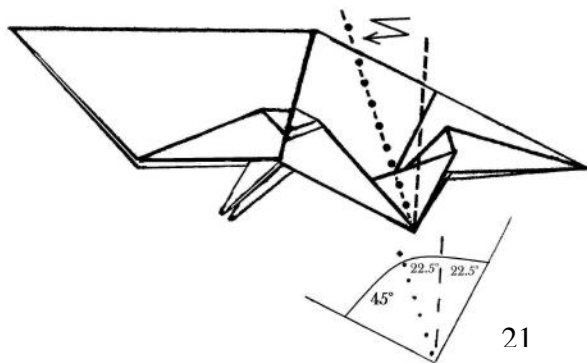

21

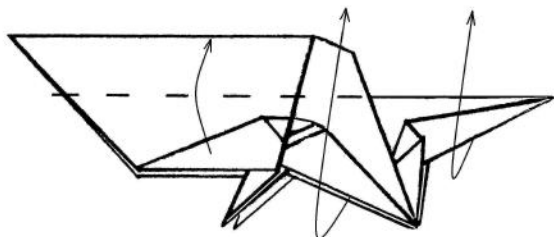

22

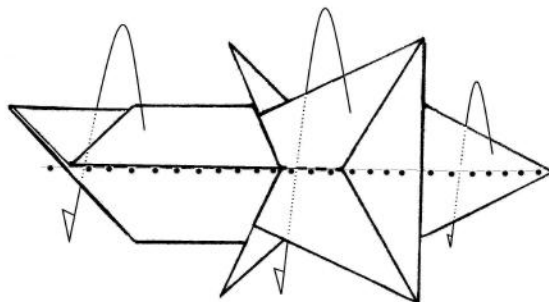

23

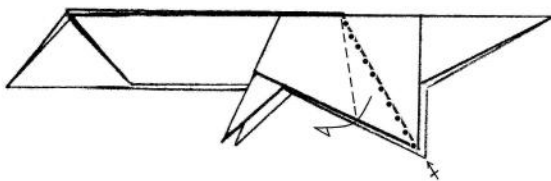

24

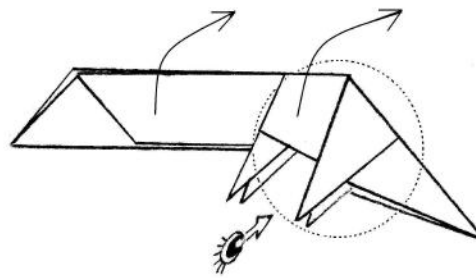

25

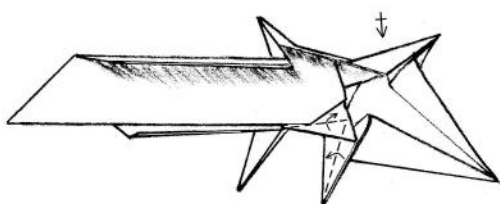

26

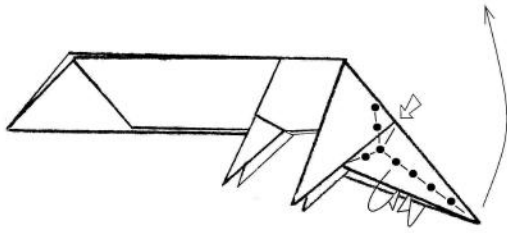

27

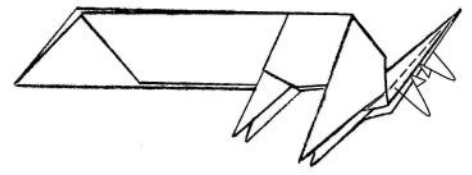

28

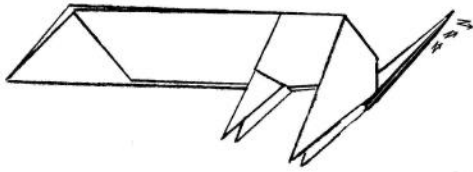

29

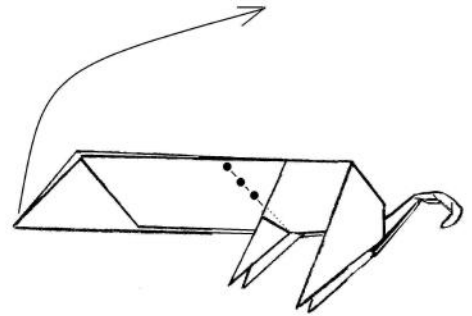

30

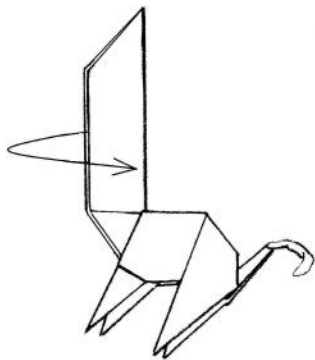

31 A

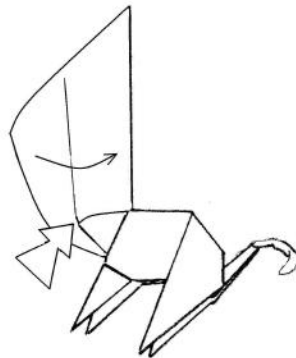

B

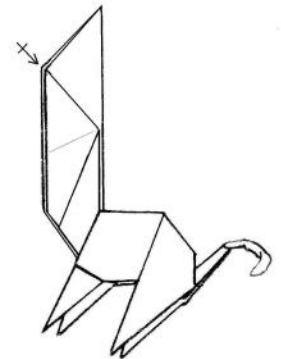

32

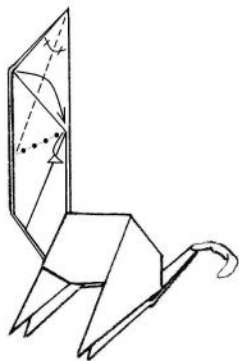

33

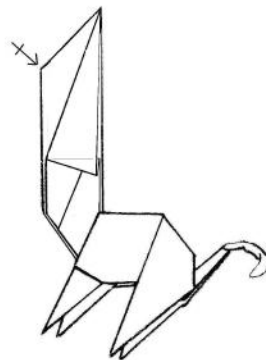

34

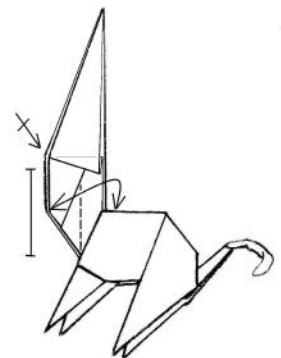

35

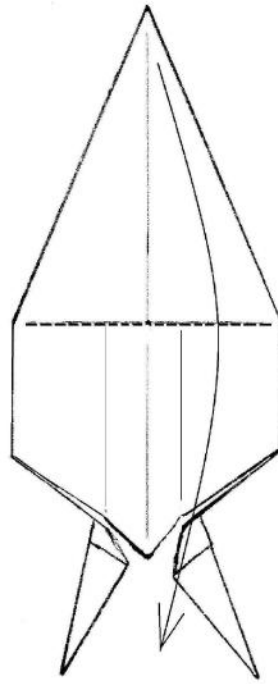
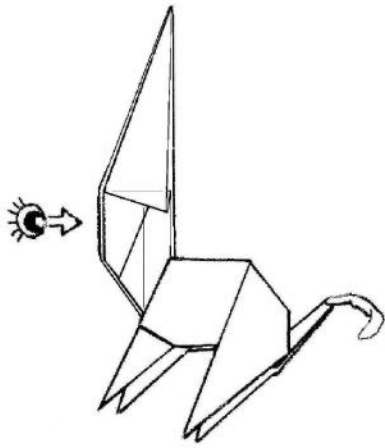

36

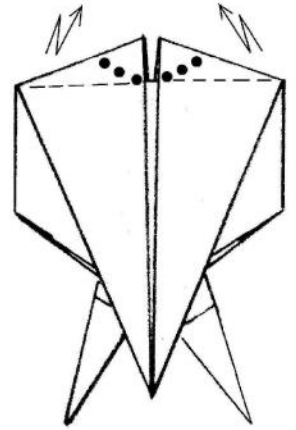

37

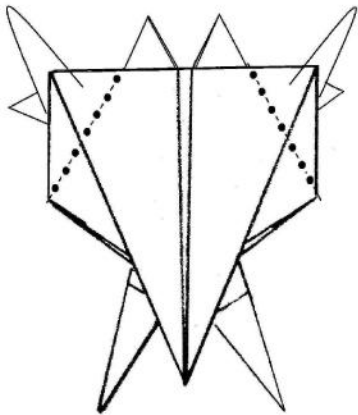

38

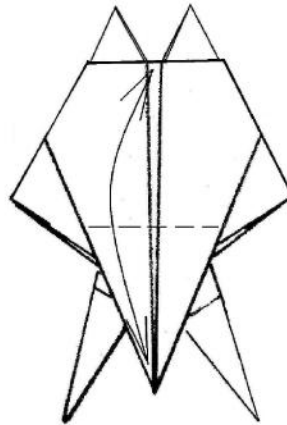

39

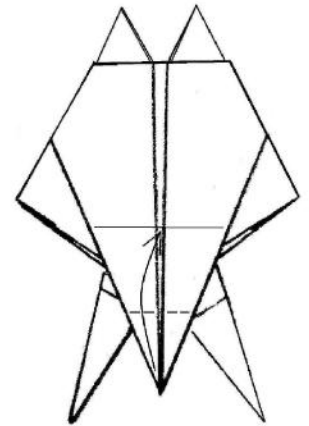

40

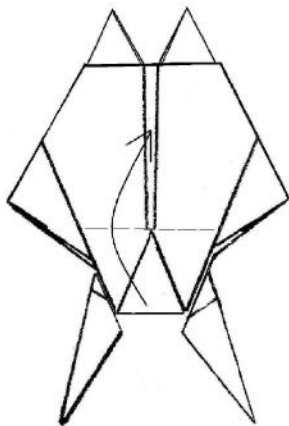

41

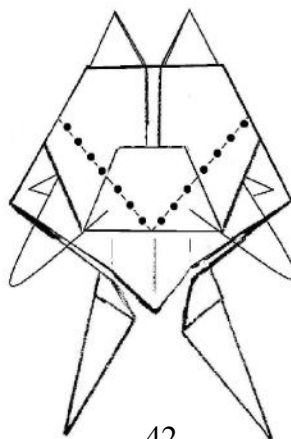

42

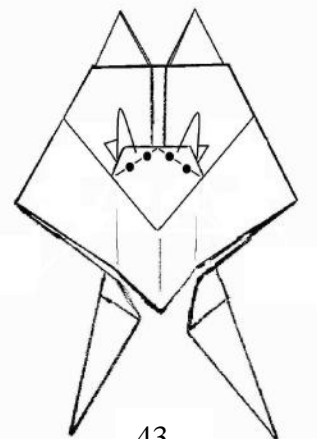

43

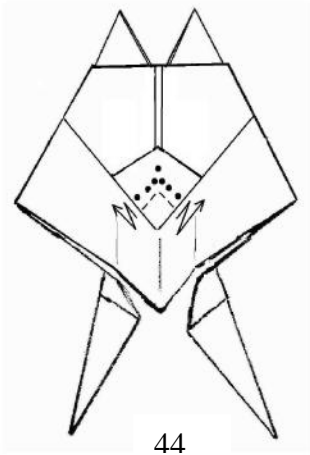

44

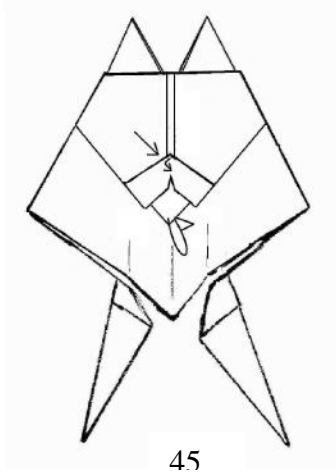

45

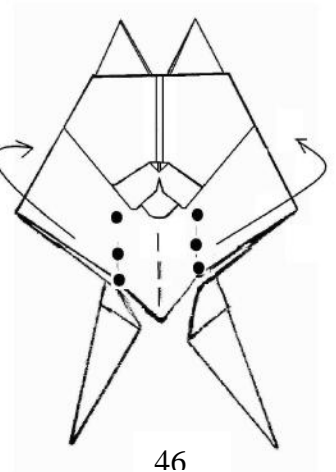

46

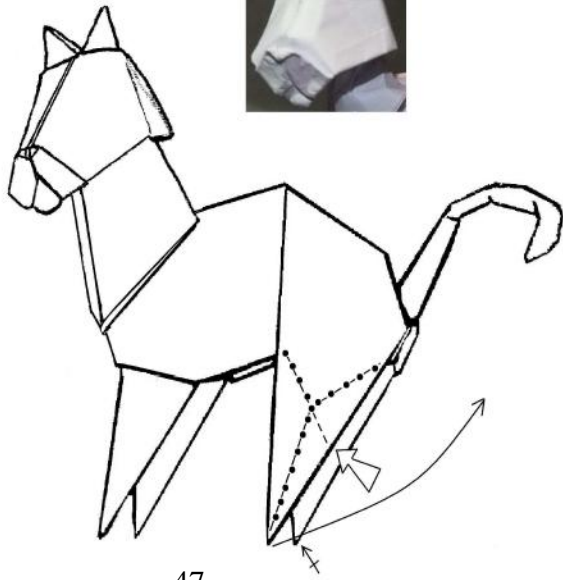

47

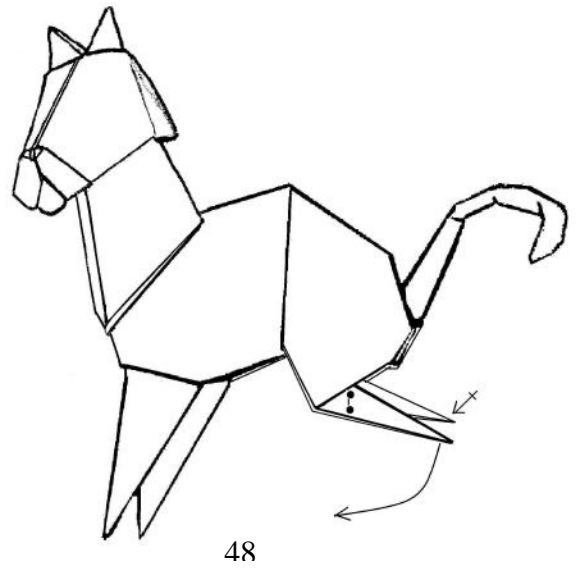

48

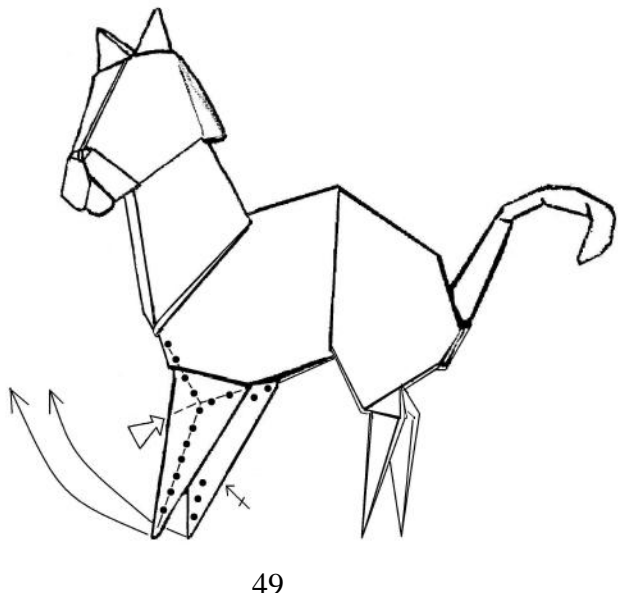

49

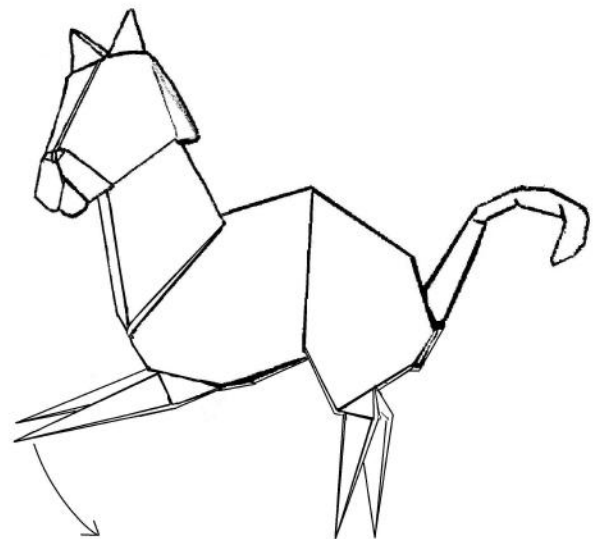

50



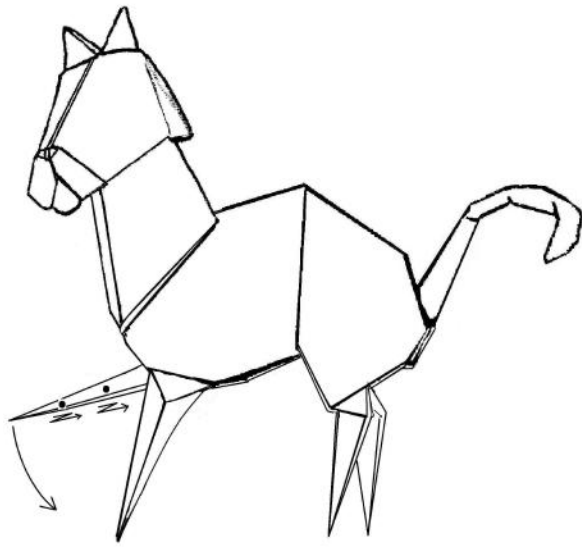

51

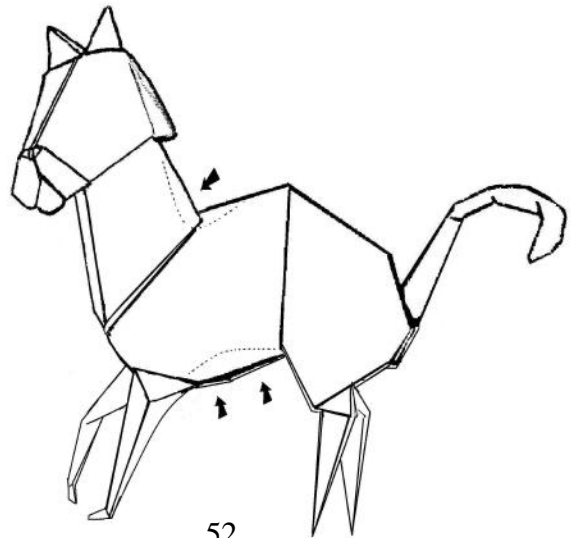

52

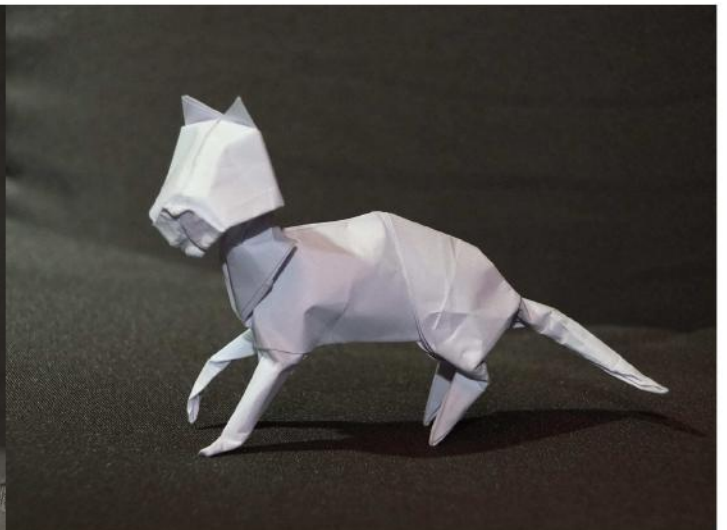
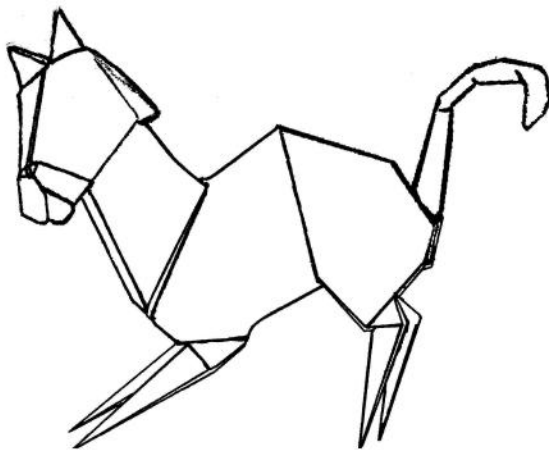

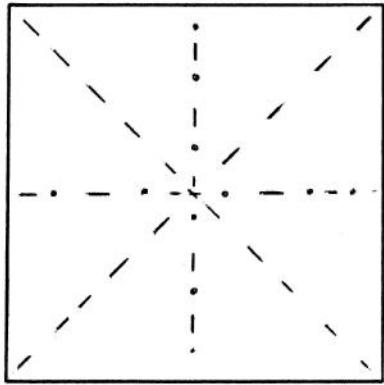

1

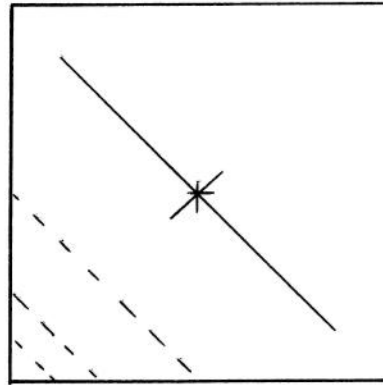

2

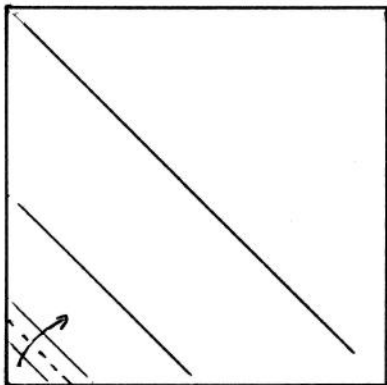

3

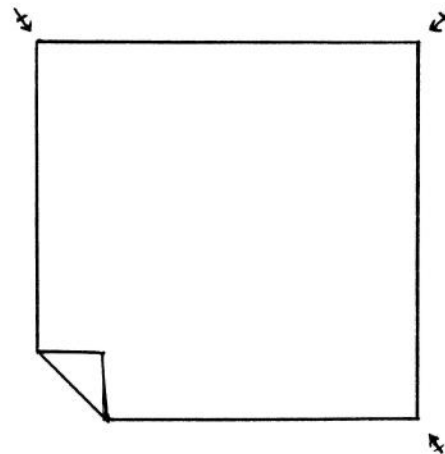

4

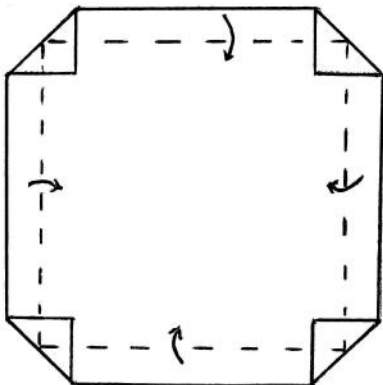

5

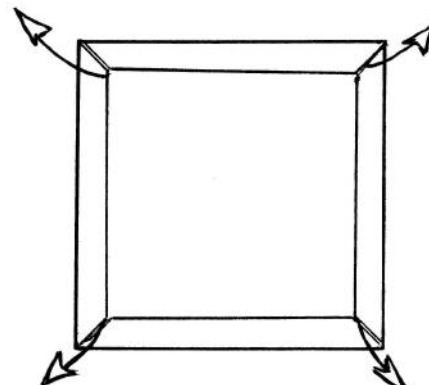

6

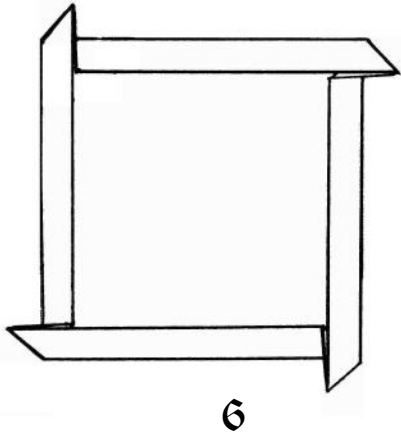

6

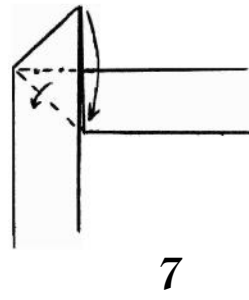

7

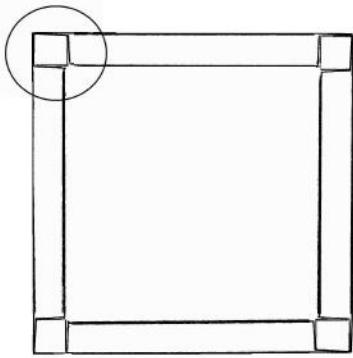

8

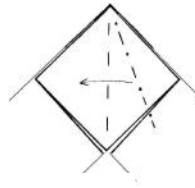

9

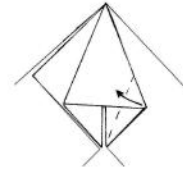

10

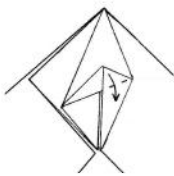

11

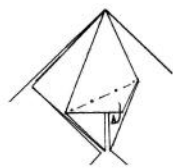

12

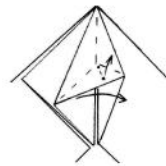

13

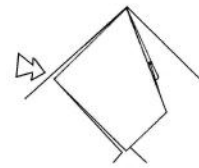

14

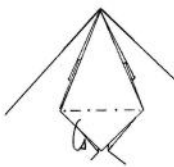

15

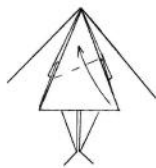

16

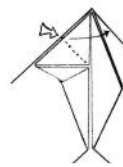

17

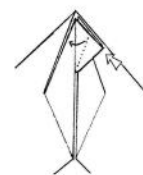

18

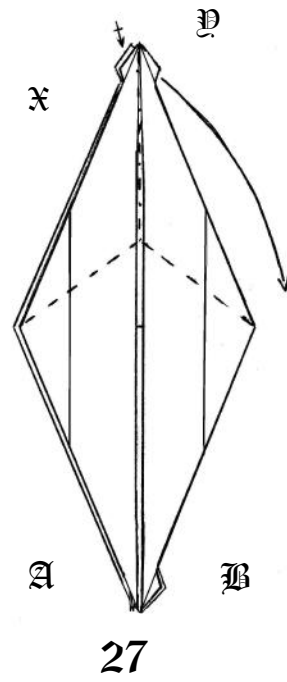
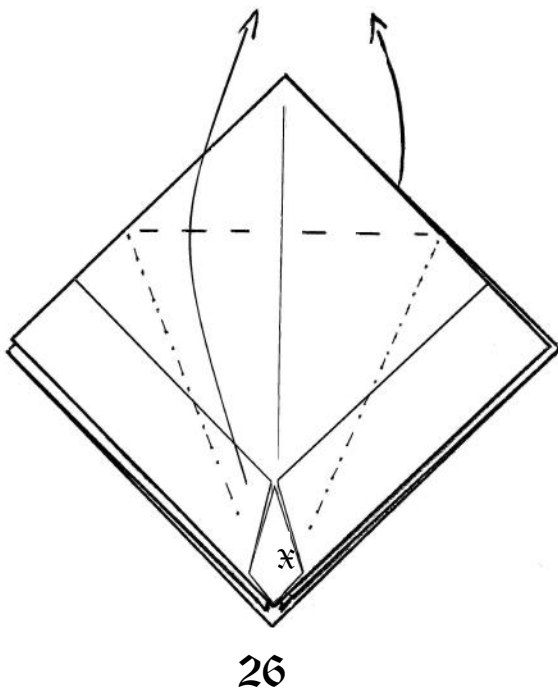
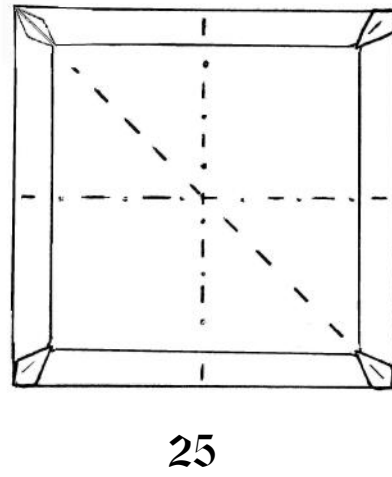
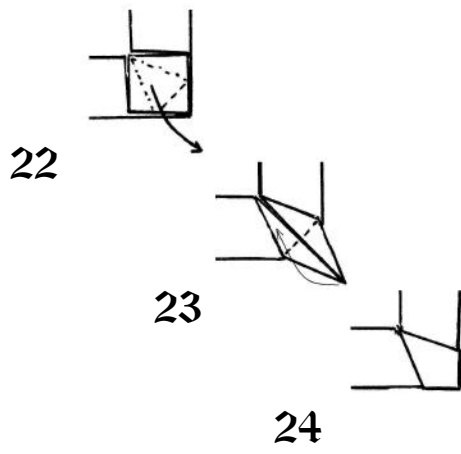
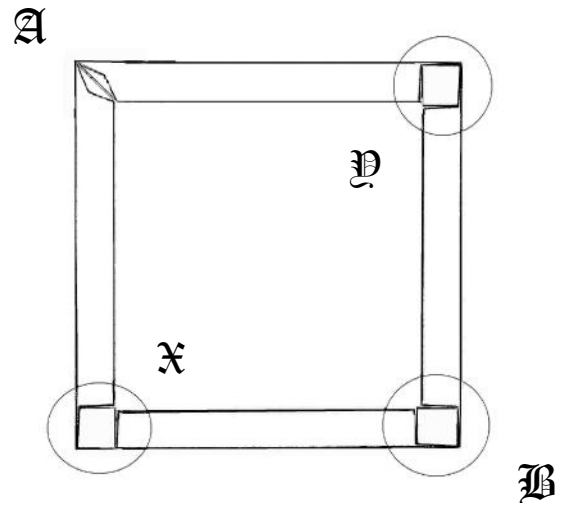
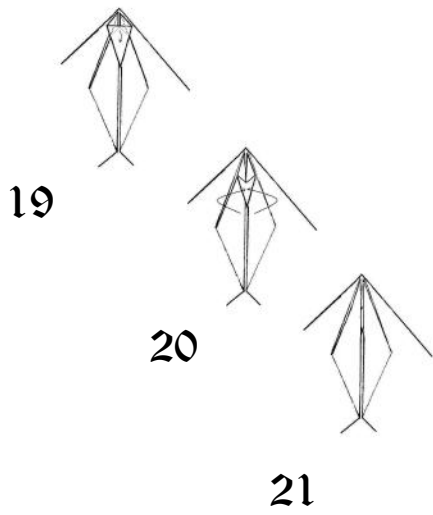

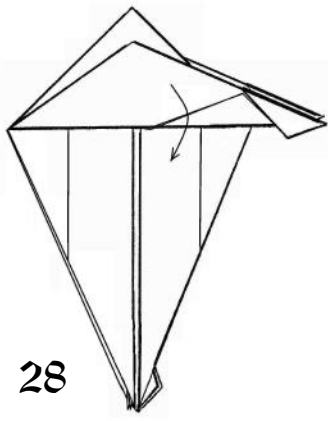

28

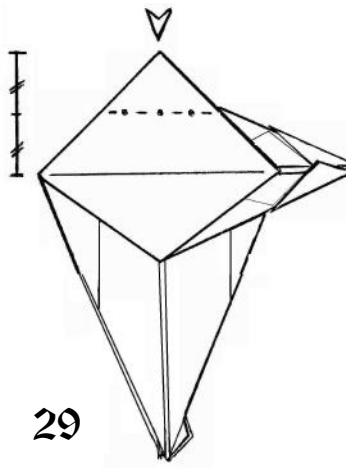

29

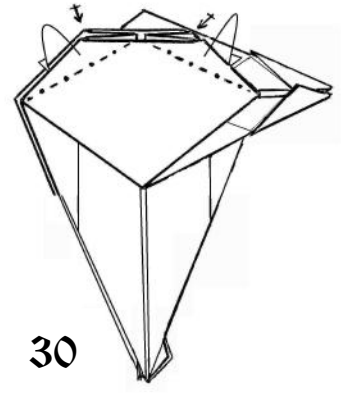

30

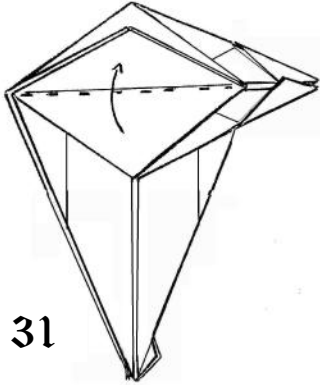

31

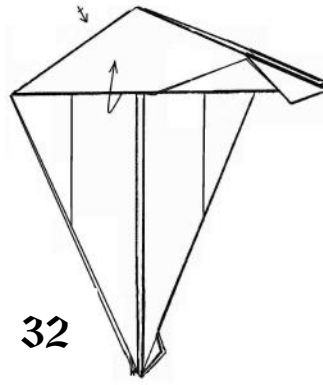

32

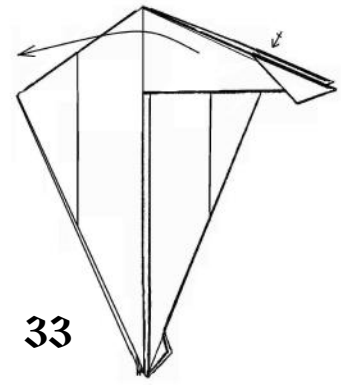

33

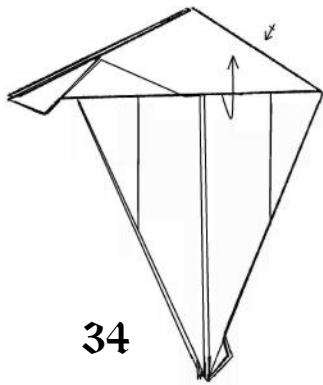

34

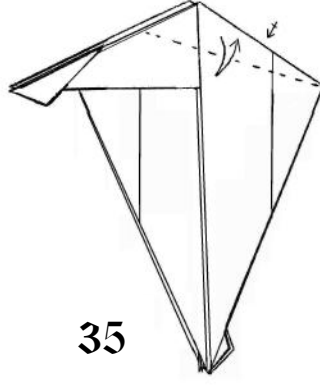

35

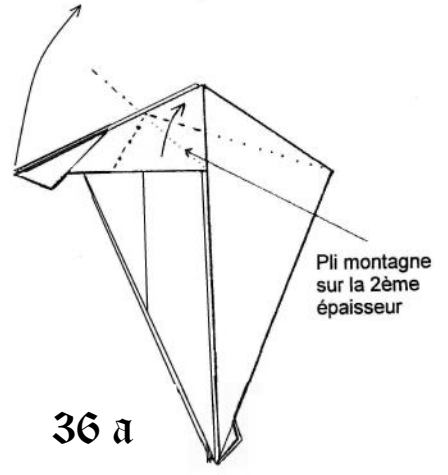

36 a

Pli montagne sur la 2ème épaisseur

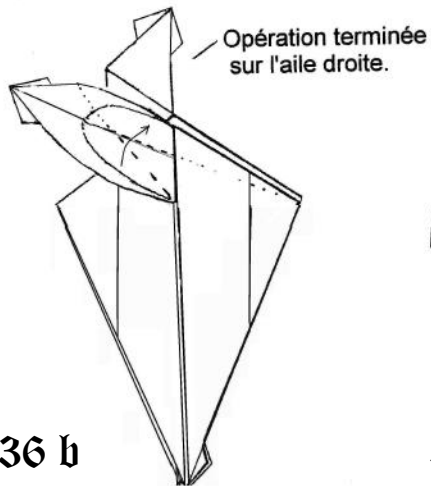

36 b

Opération terminée sur l'aile droite.

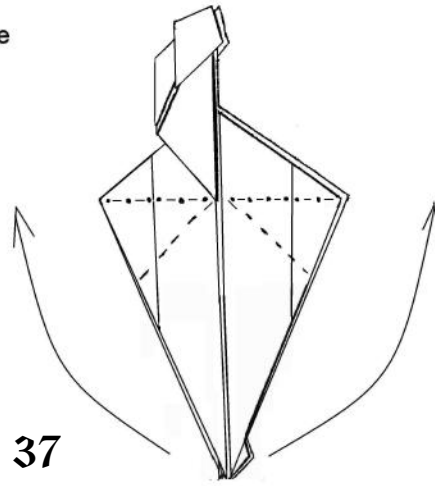

37

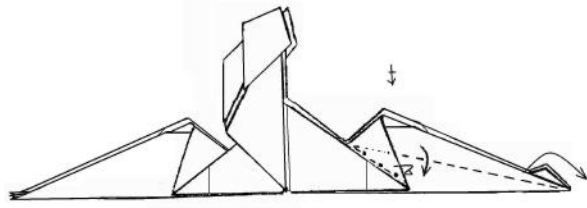

38

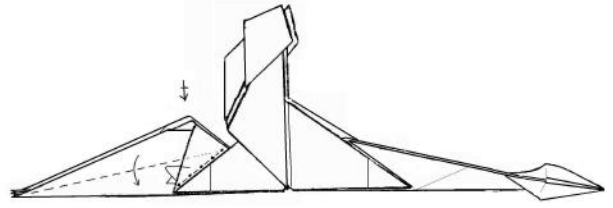

39

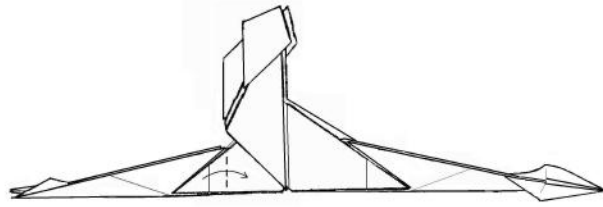

40

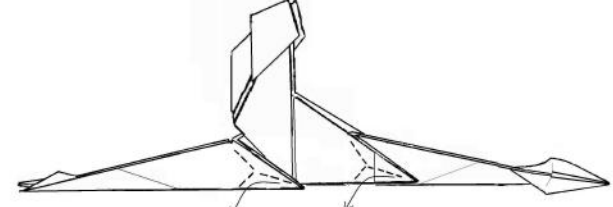

41

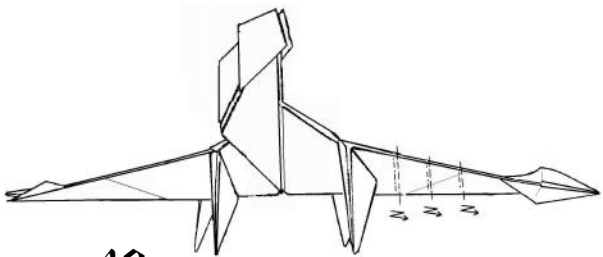

42

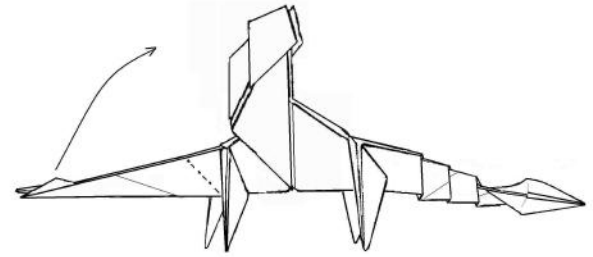

43

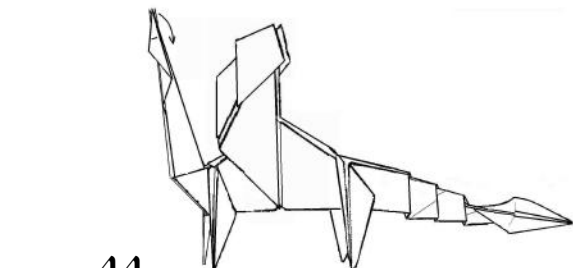

44

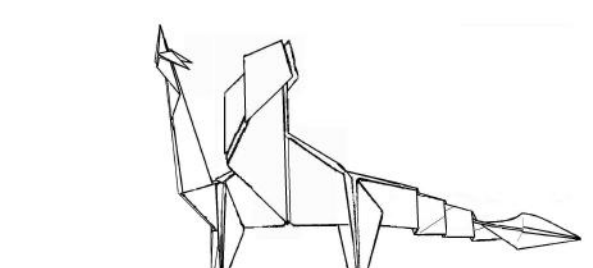

45

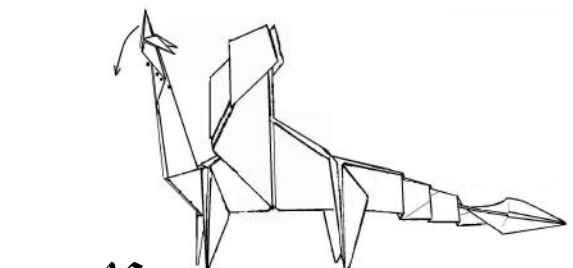

46

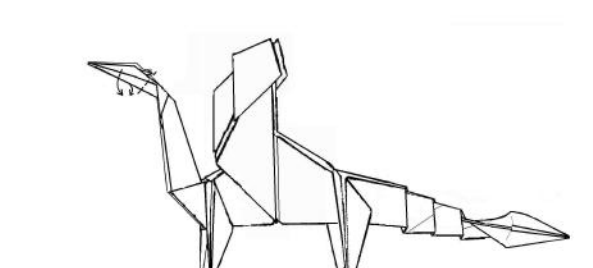

47

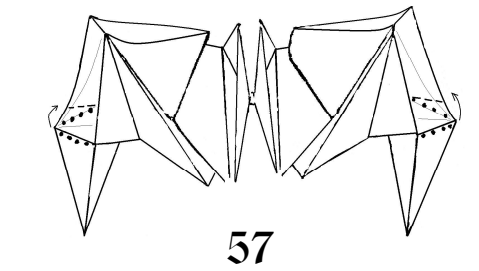
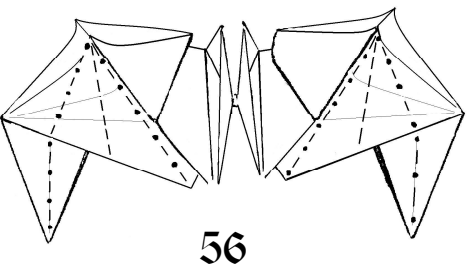
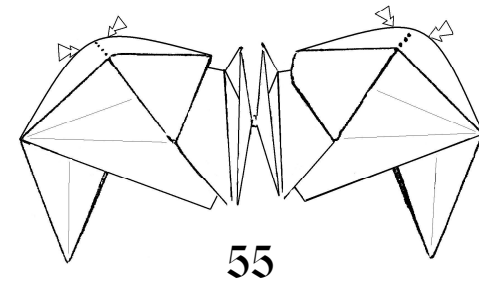
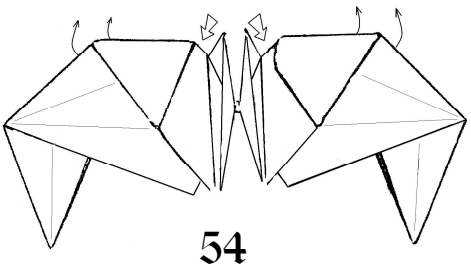
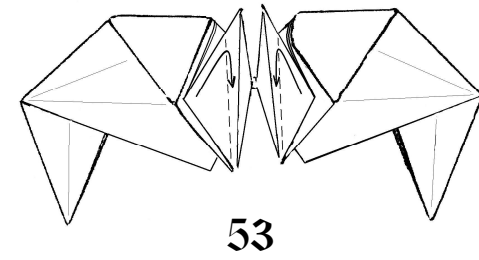
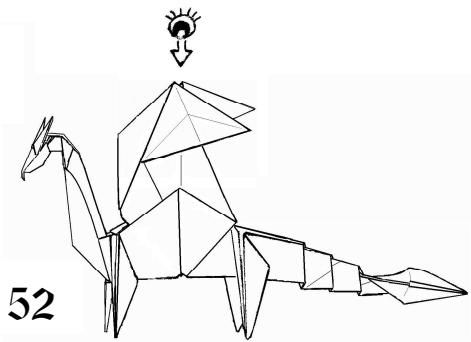
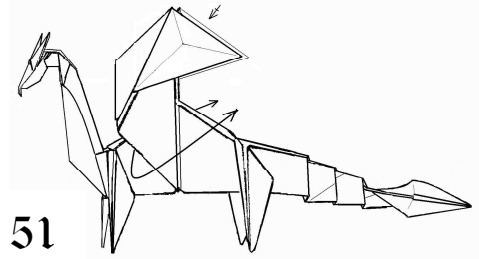
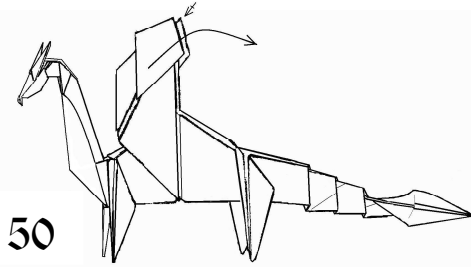
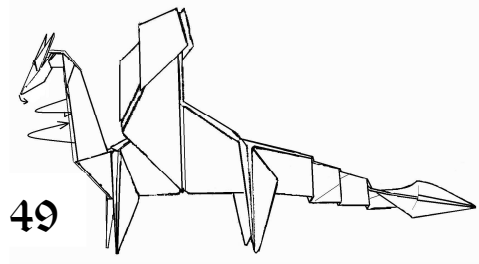
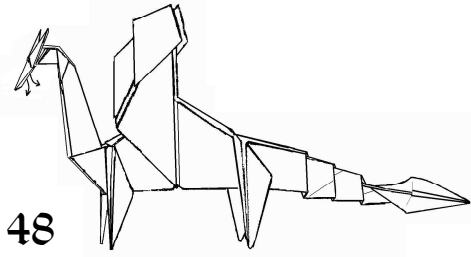

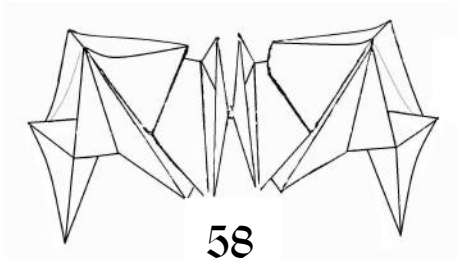

58

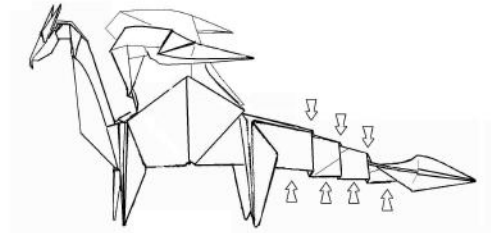

59



LIBELLULE

(création : 2003, diagramme : 2012)

Eric VIGIER

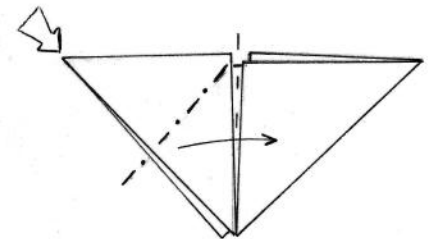
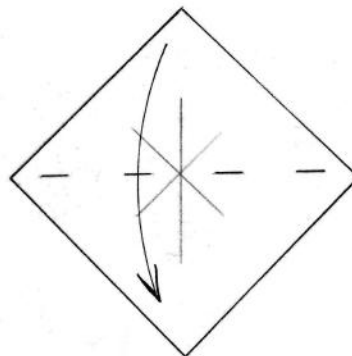
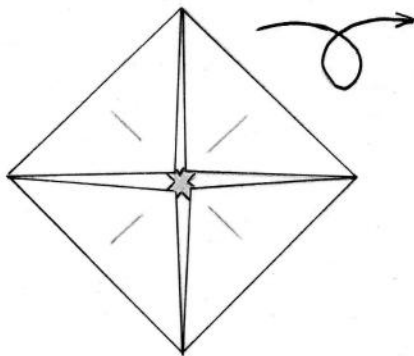
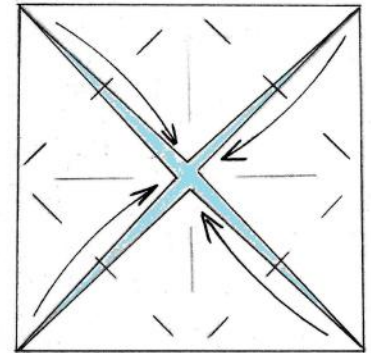
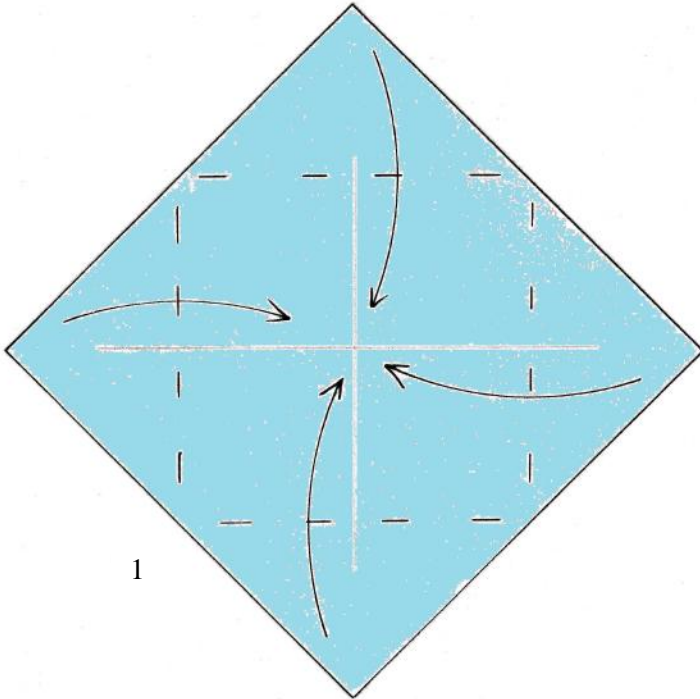

3

4

5

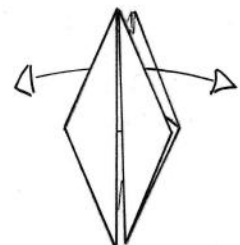
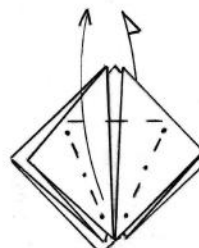
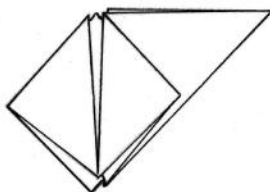

6

7

8

Répéter l' étape 5 à l' opposé

Sortir les parties cachées et répéter derrière

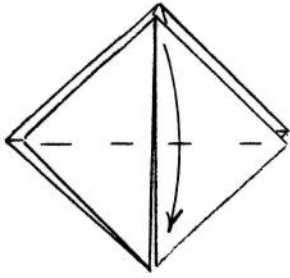

9

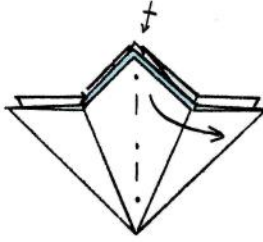

10

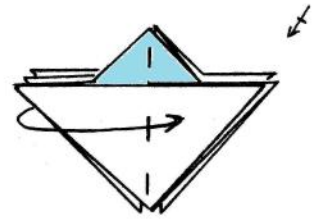

11

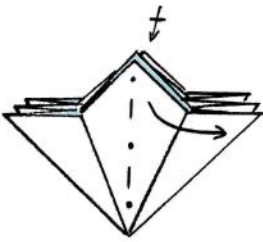

12

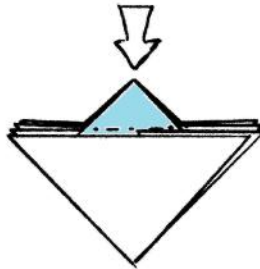

13

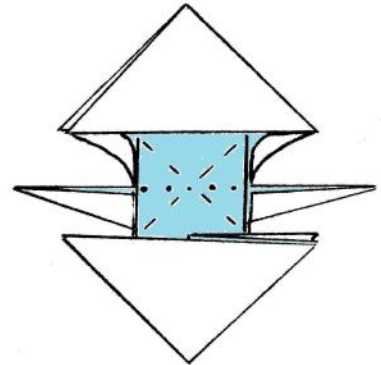

13b

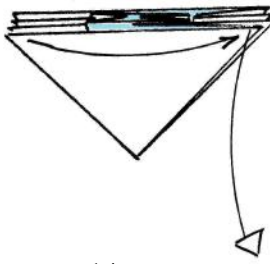

14

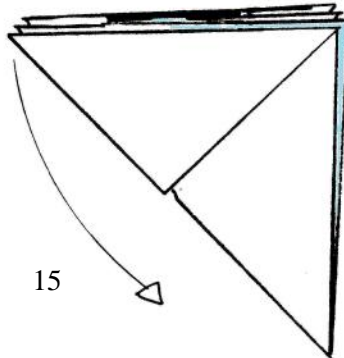

15

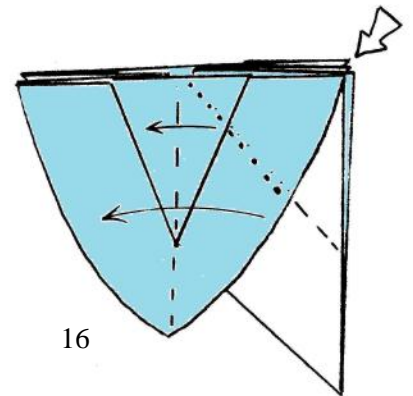

16

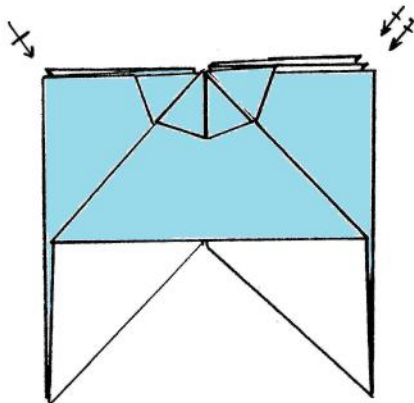

17

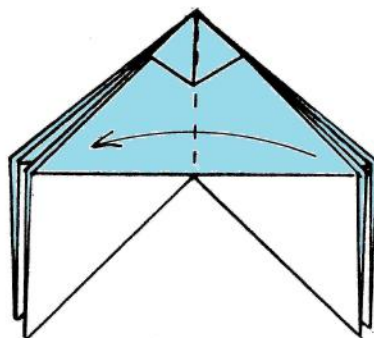

18

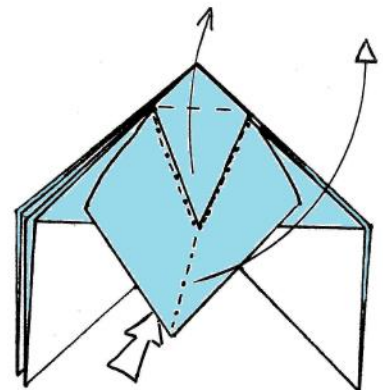

19

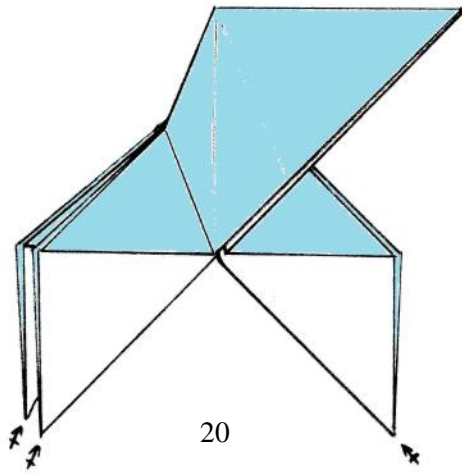

20

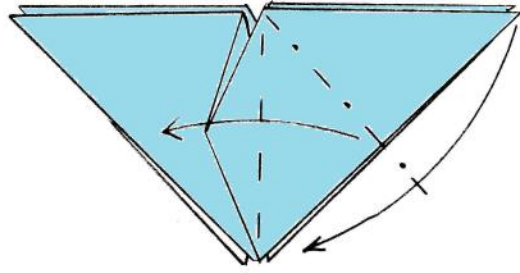

21

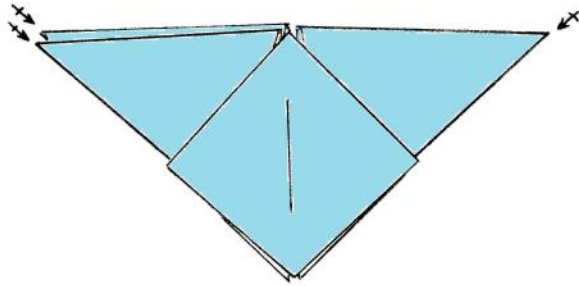

22

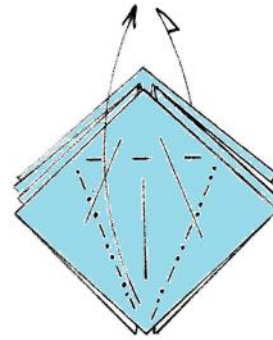

23

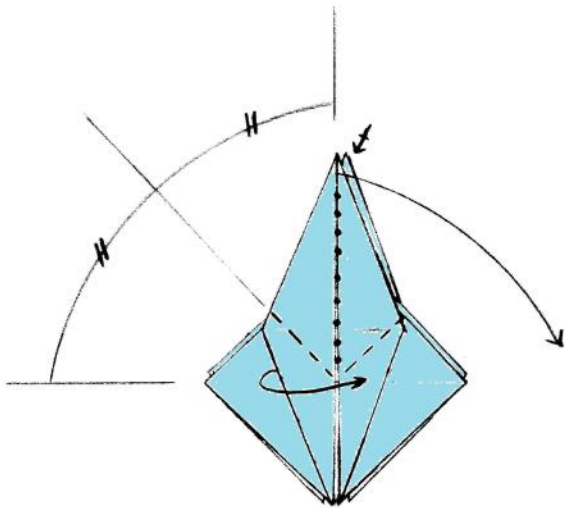

24

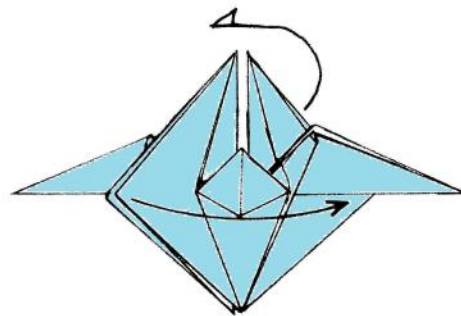

25

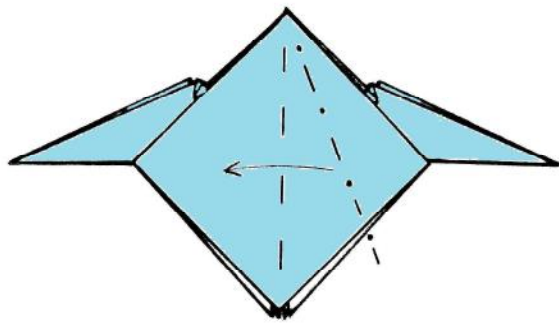

26

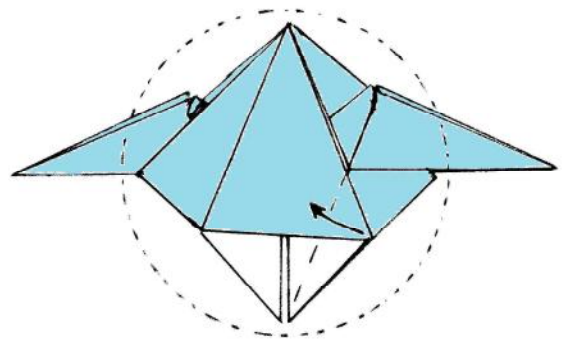

27

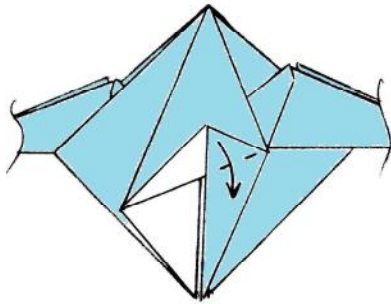

28

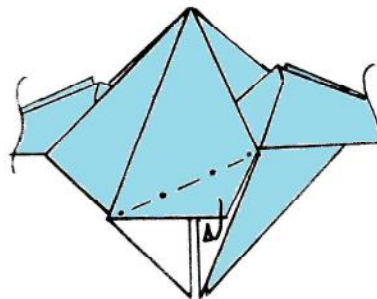

29

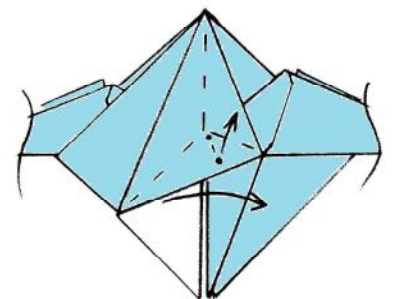

30

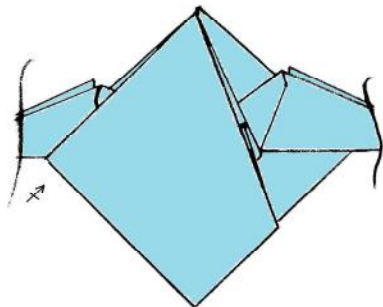

31

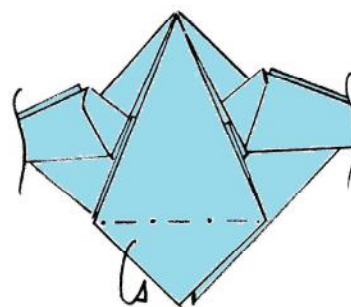

32

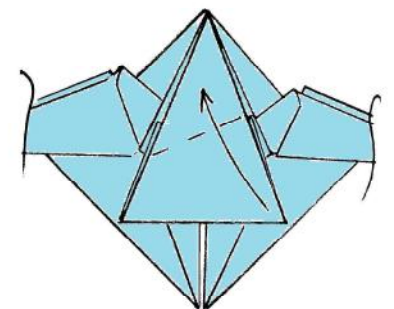

33

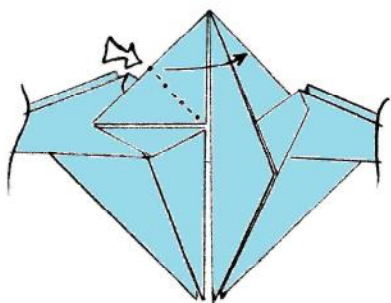

34

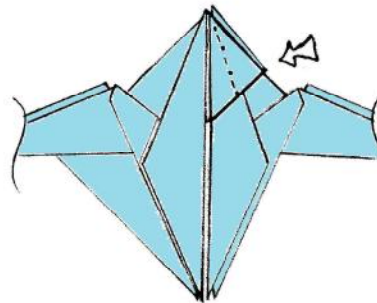

35

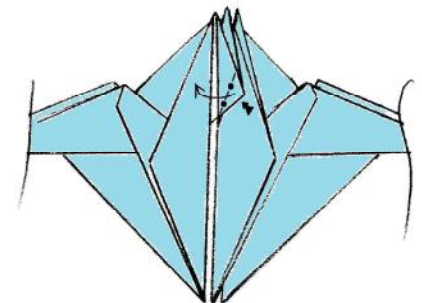

36

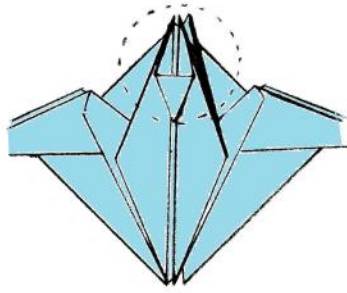

FOCUS

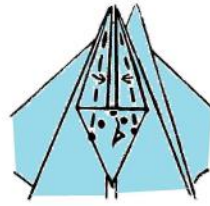

37

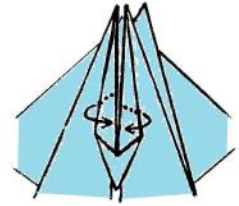

38

Placer sous la couche inférieure

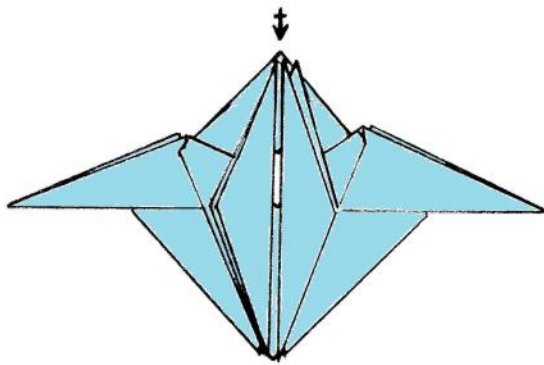

39

Répéter de 26 à 38

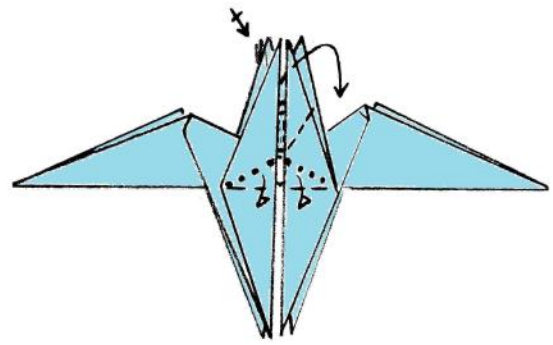

40

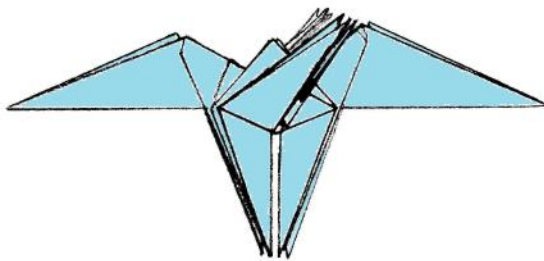

41

Vue en 3D

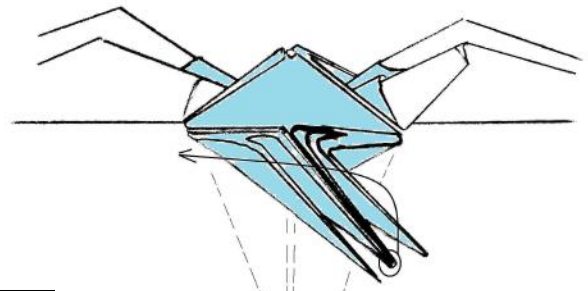

41 A

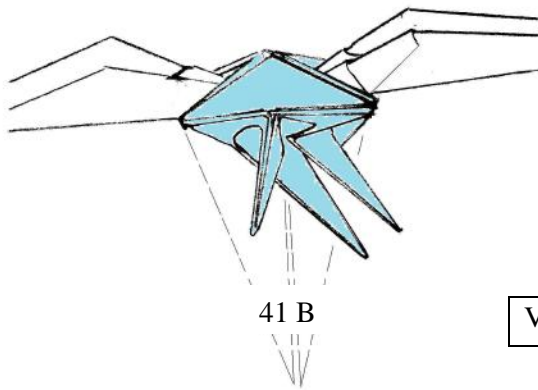

41 B

Vue en 3D

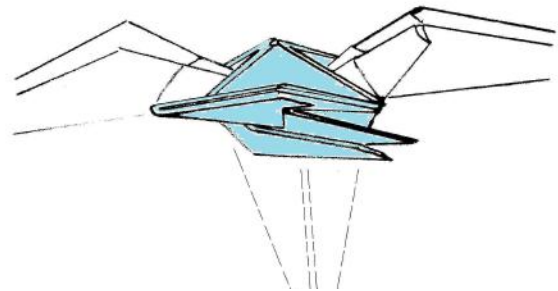

41 C

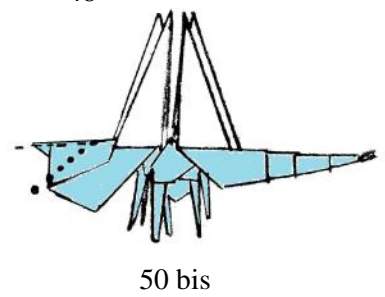
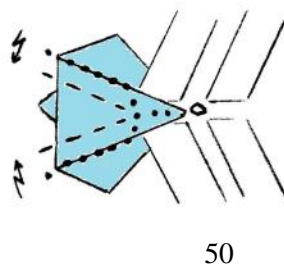
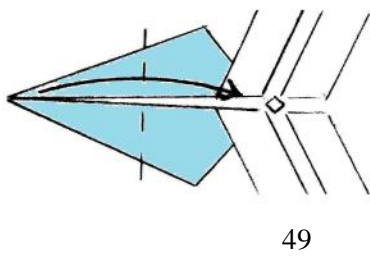
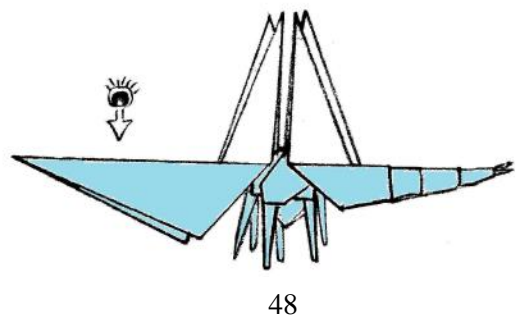
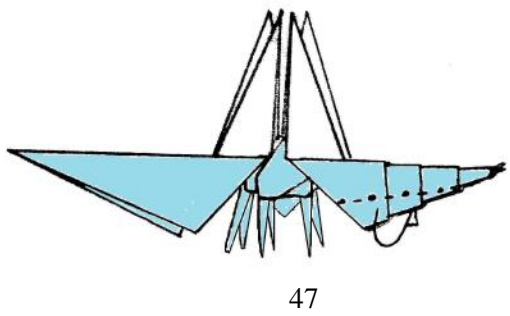
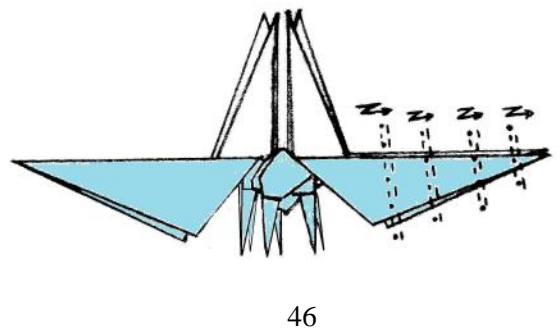
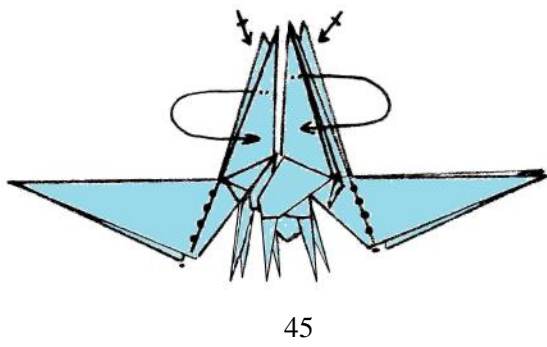
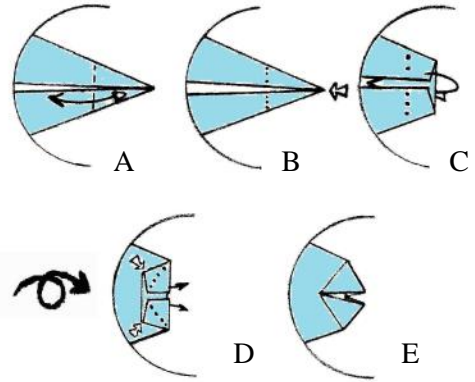
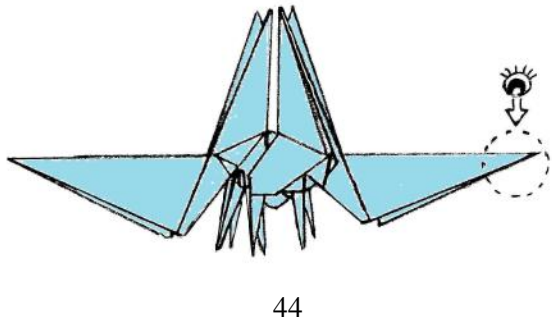
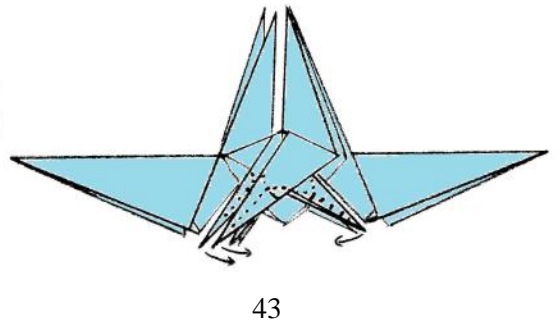
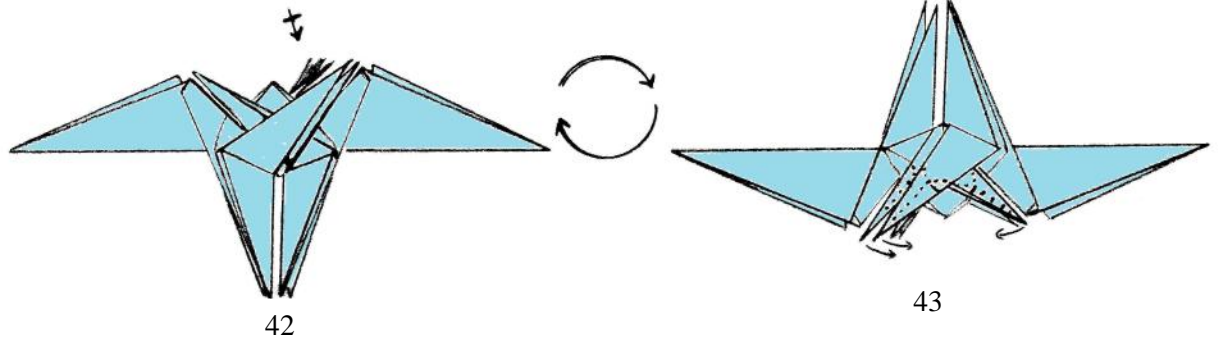

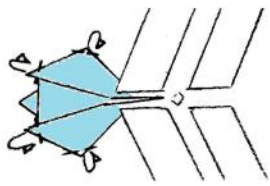

51

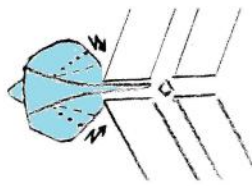

52

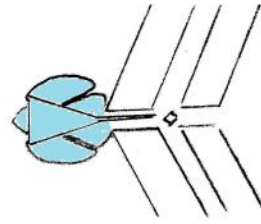

53

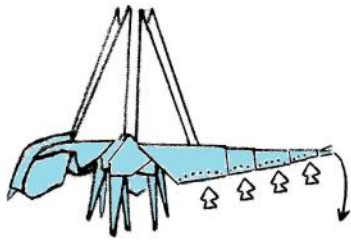

54

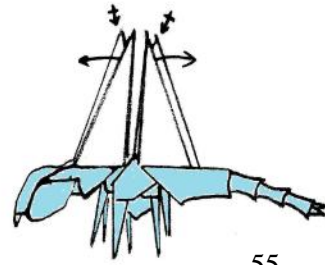

55

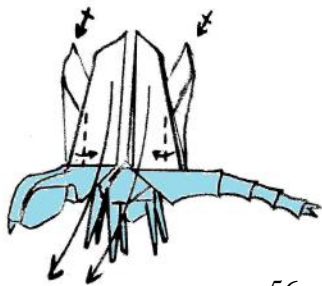

56

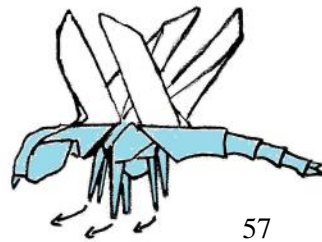

57

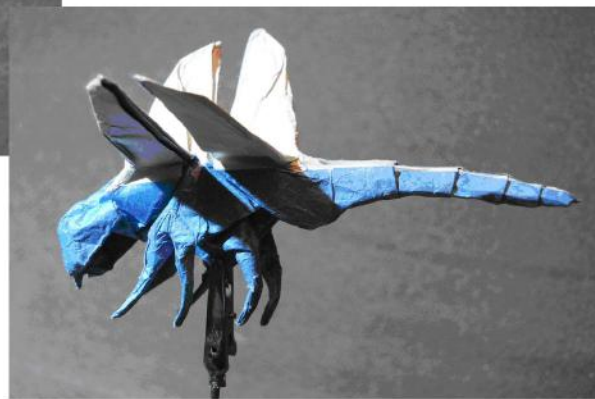
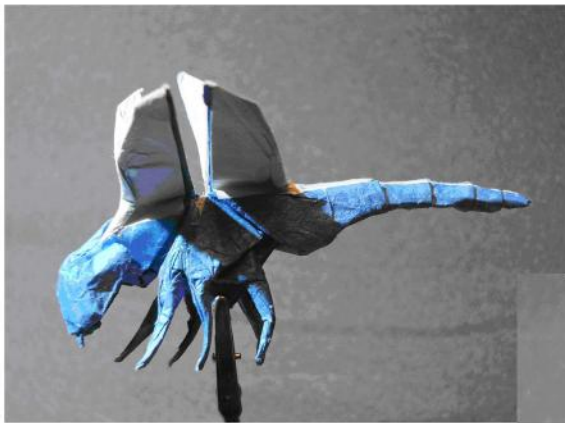

LE LAPIN (2009)

Eric Vigier

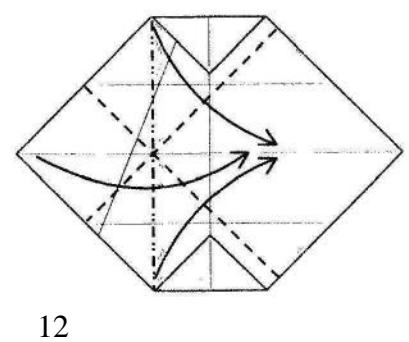
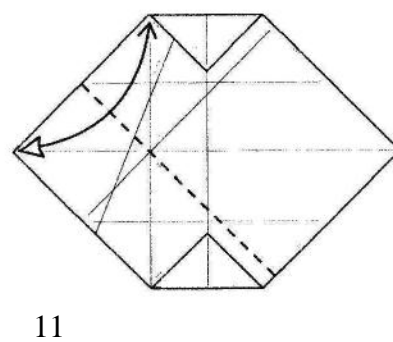
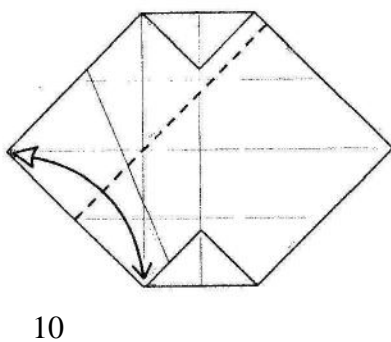
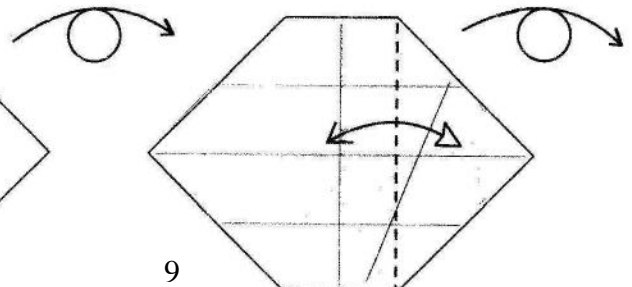
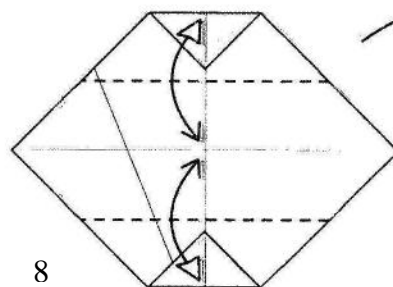
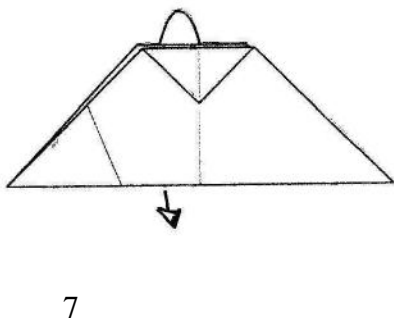
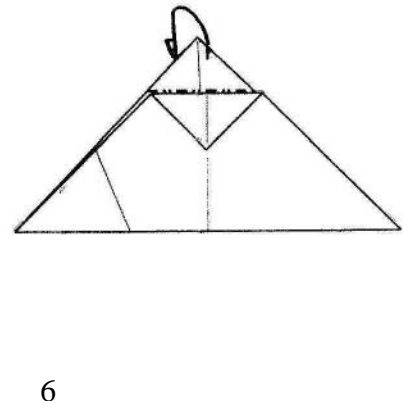
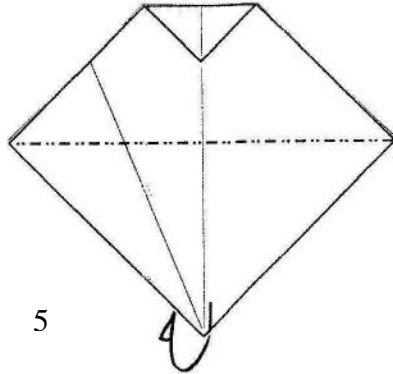
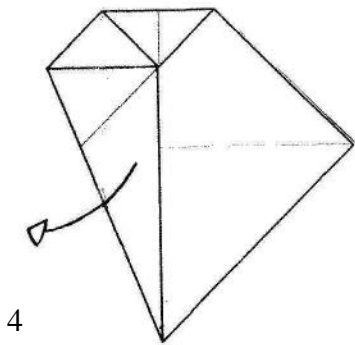
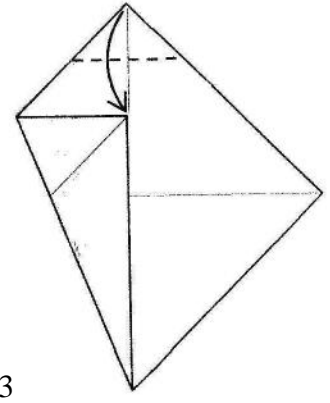
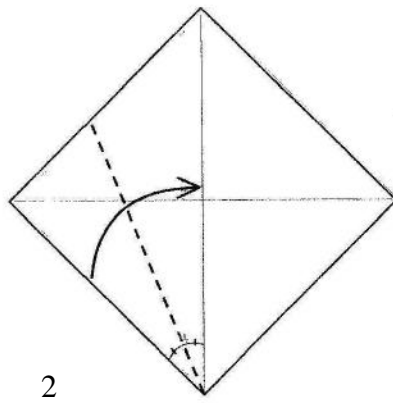
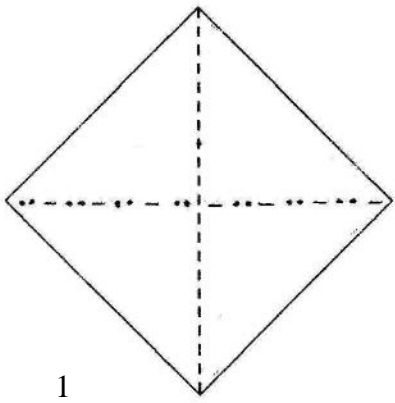

90°

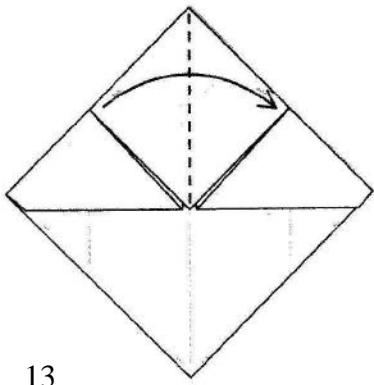

13

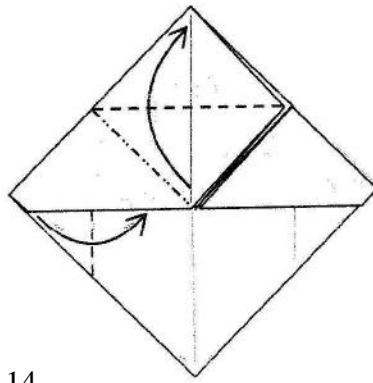

14

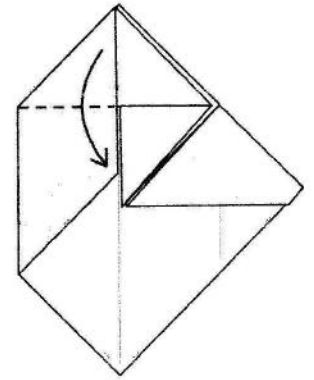

15

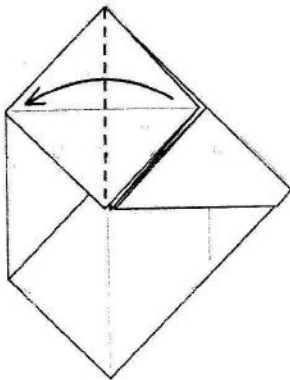

16

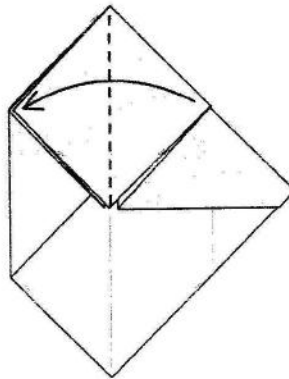

17

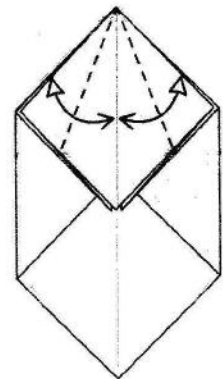

18

Répéter de 14 à 17 sur la droite

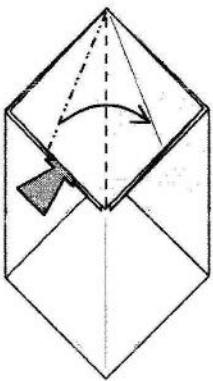

19

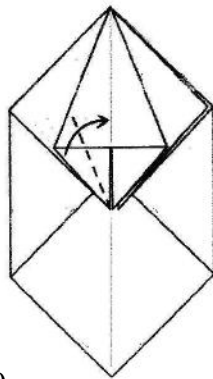

20

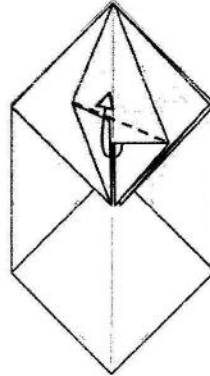

21

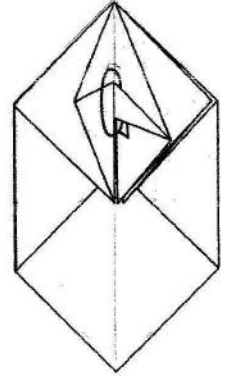

22

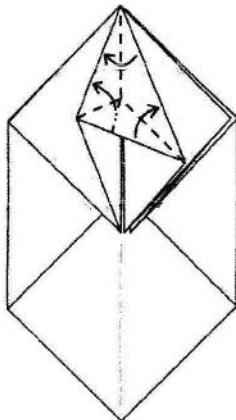

23

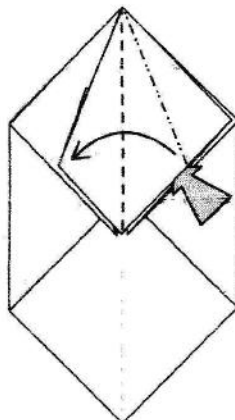

24

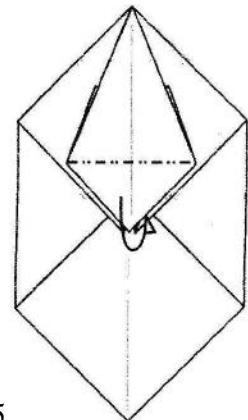

25

Répéter de 20 à 24 sur la droite

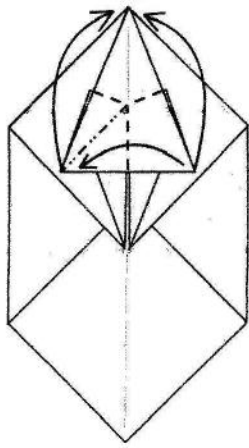

26

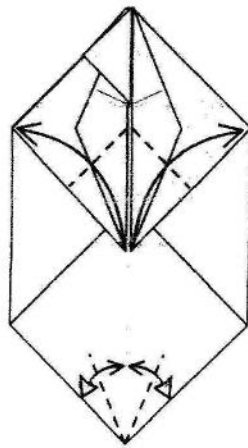

27

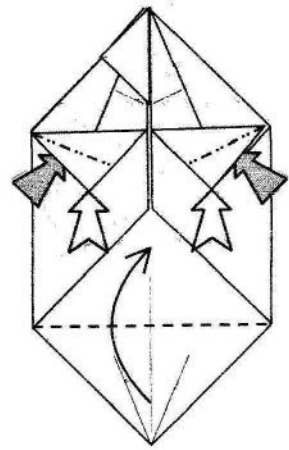

28

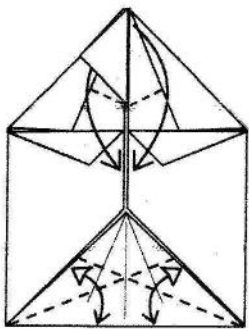

29

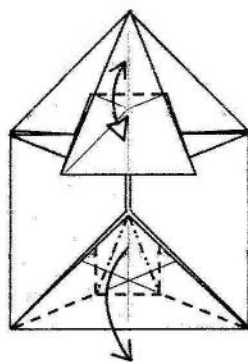

30

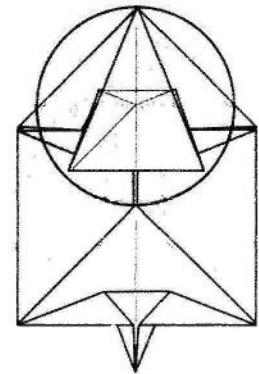

31

Zoom

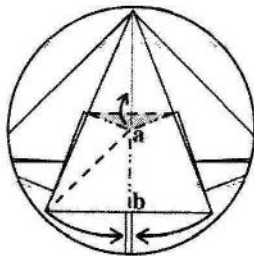

32

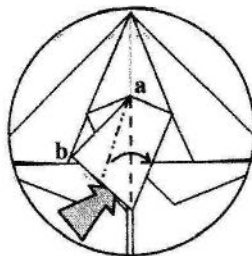

33

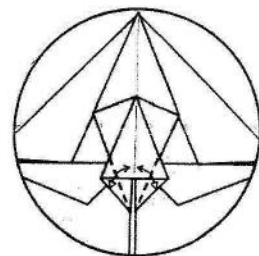

34

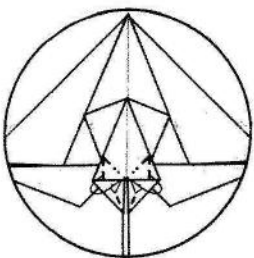

35

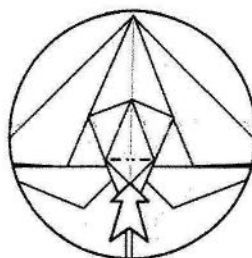

36

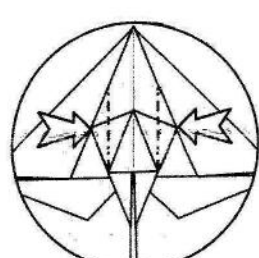

37

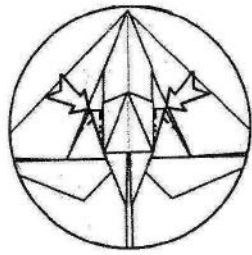

38

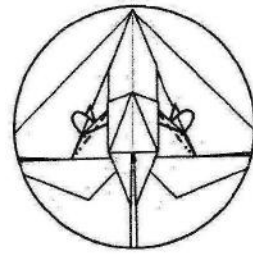

39

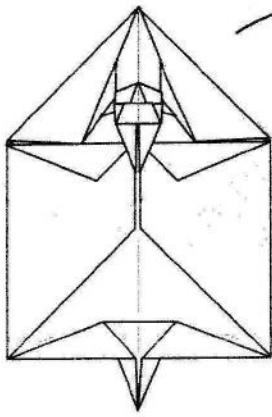

40

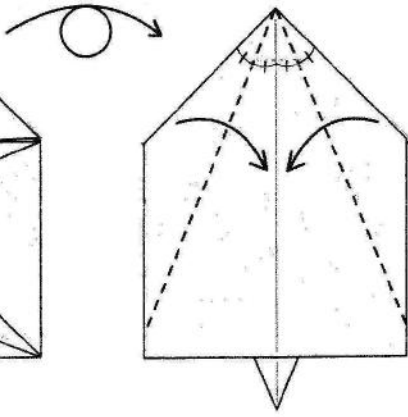

41

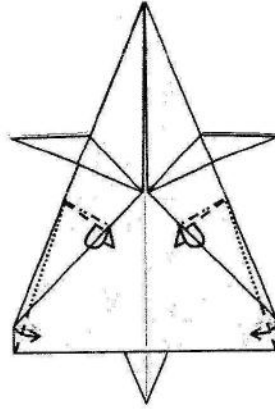

42

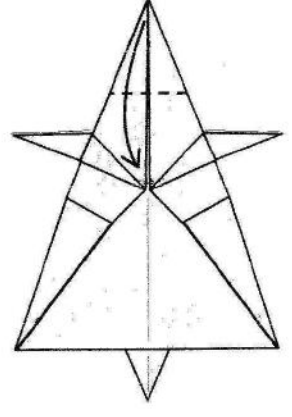

43

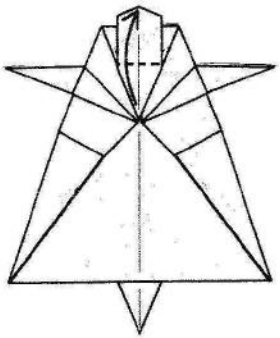

44

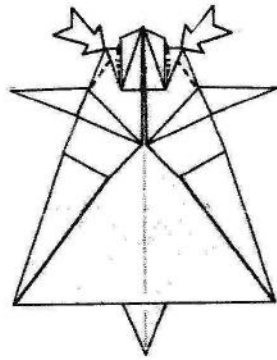

45

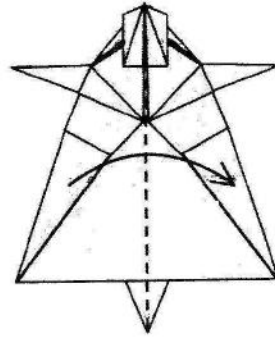

46

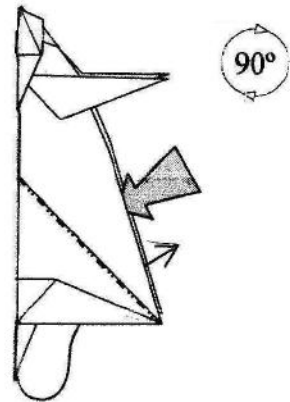

47

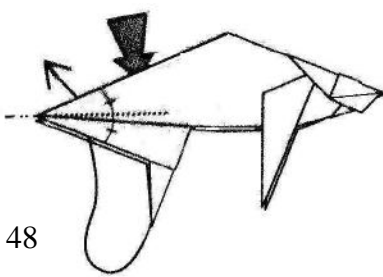

48

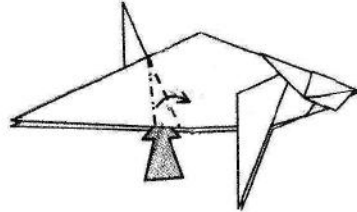

49

Répéter derrière

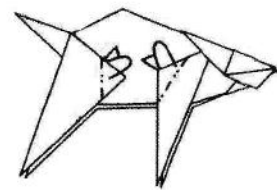

50

Répéter derrière

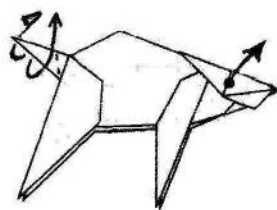

51

Remonter la tête par un pli pivot

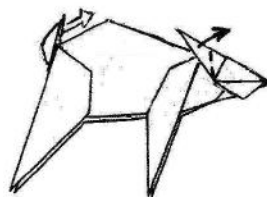

52

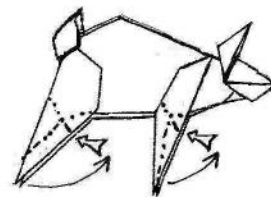

53

Double oreille de lapin
Répéter derrière

54

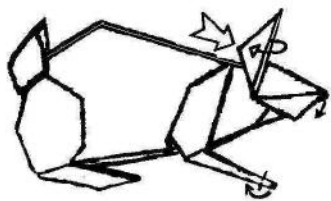

Former les oreilles
Baisser la mâchoire inférieure

55

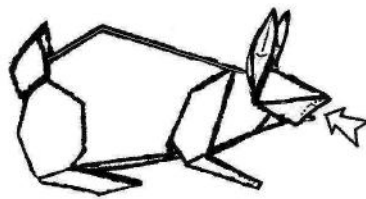

56



Fin.



Je tiens à remercier mon ordinateur et la fonction « copier/coller » pour l'aide apportée à la réalisation de ces diagrammes ainsi que mes chères petites mains !

Eric VIGIER.